

Cermet Potentiometer Series

KLS4-3266 Cermet Potentiometer Series

Electrical characteristics

Standard Resistance Range: 10Ω ~ 2MΩ
 Resistance Tolerance: ± 10%
 Terminal Resistance: ≤ 1%R or 2Ω Max
 Contact Resistance Variation: CRV ≤ 3%R or 3Ω Max
 Insulation Resistance: $R_i \geq 1G\Omega$
 Withstand Voltage: 640VAC
 Maximum Wiper Current: 100mA
 Effective electrical travel: 30±2 turns nom

Environmental characteristics

Power Rating (300 volts max.): 70 °C : 0.5 W, 125 °C : 0 W
 Temperature Range : -55°C ~ +125°C
 Temperature Coefficient : ±250ppm/°C , ±100ppm/°C
 Vibration: 390m/s², 4000 cycles, ΔR ≤ ±5%R
 Collision: 10 ~ 500Hz, 0.75mm, or 98m/s², 6h, ΔR ≤ ±5% R,
 Δ(Uab / Uac) ≤ ±7.5%
 Temperature Variation: 30min, 5 cycle, ΔR ≤ ±5% R, Δ(Uab / Uac) ≤ ±5%
 Climate category: ΔR ≤ ±3%R, $R_i \geq 100M\Omega$
 70°C Electrical endurance: 0.5W, 1000h, ΔR ≤ ±3%R
 Mechanical endurance: 200 cycles, ΔR ≤ ±10%R, CRV ≤ 3%R or 5Ω
 Steady damp heat: ΔR ≤ ±10%R, $R_i \geq 100M\Omega$

Physical characteristics

Total mechanical travel : 30±2cycles
 Starting torque : ≤ 35mN. m
 Standard packaging: 50pcs/tube

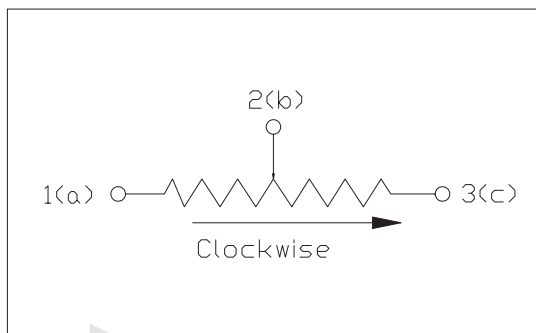

Resistance (Ω)	Code
10	100
20	200
50	500
100	101
200	201
500	501
1000	102
2000	202
10000	103
20000	203
50000	503
100000	104
200000	204
500000	504
1000000	105
2000000	205

ORDER INFORMATION

Product NO.: KLS4-3266 W-103

Pos. NO. _____ 103:Resistance Code
 3266:Model _____ W:Style

Cermet Potentiometer Series

KLS4-3266 Cermet Potentiometer Series

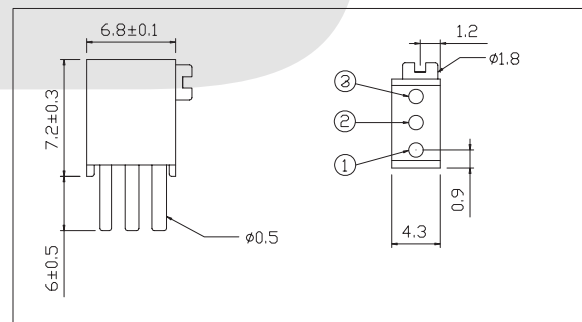
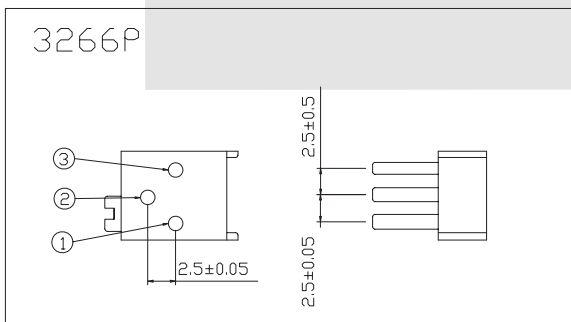
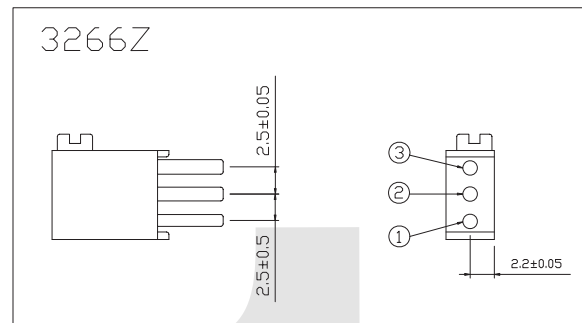
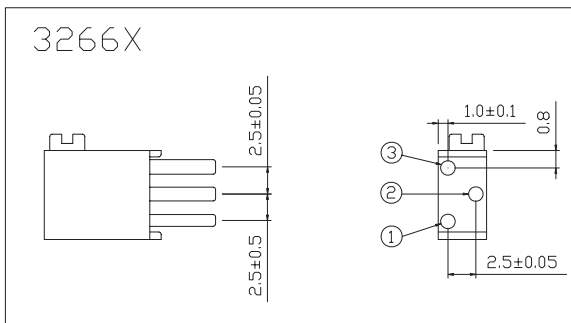
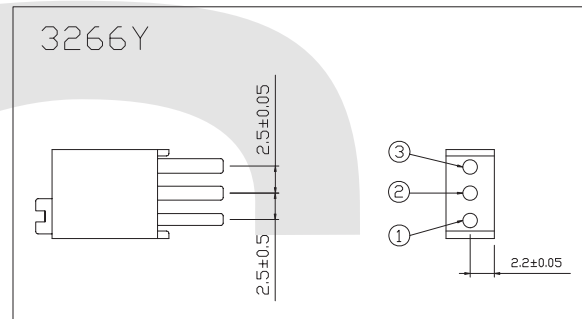
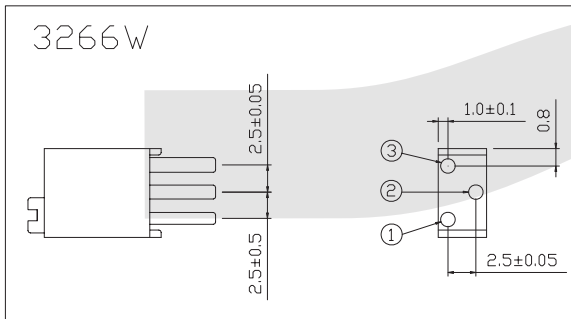

ORDER INFORMATION

Product NO.: KLS4-3266 W-103

Pos. NO. _____ 103:Resistance Code
3266:Model _____ W:Style