

1.5SMC Series

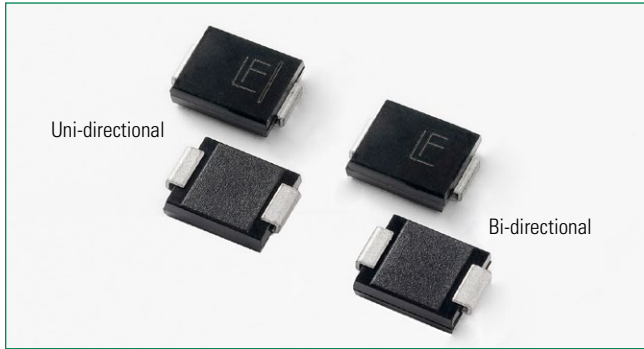

Agency Approvals

Agency	Agency File Number
	E230531

Maximum Ratings and Thermal Characteristics (T_A=25°C unless otherwise noted)

Parameter	Symbol	Value	Unit
Peak Pulse Power Dissipation at T _A =25°C by 10/1000µs Waveform (Fig.2)(Note 1), (Note 2), (Note 5)	P _{PPM}	1500	W
Power Dissipation on Infinite Heat Sink at T _L =50°C	P _D	6.5	W
Peak Forward Surge Current, 8.3ms Single Half Sine Wave (Note 3)	I _{FSM}	200	A
Maximum Instantaneous Forward Voltage at 100A for Unidirectional Only (Note 4)	V _F	3.5/5.0	V
Operating Temperature Range	T _J	-65 to 150	°C
Storage Temperature Range	T _{STG}	-65 to 175	°C
Typical Thermal Resistance Junction to Lead	R _{θJL}	15	°C/W
Typical Thermal Resistance Junction to Ambient	R _{θJA}	75	°C/W

Notes:

1. Non-repetitive current pulse, per Fig. 4 and derated above T_J (initial) = 25°C per Fig. 3.
2. Mounted on copper pad area of 0.31x0.31" (8.0 x 8.0mm) to each terminal.
3. Measured on 8.3ms single half sine wave or equivalent square wave for unidirectional device only, duty cycle=4 per minute maximum.
4. V_F < 3.5V for single die parts and V_F < 5.0V for stacked-die parts.
5. The P_{PPM} of stacked-die parts is 2000W and please contact littelfuse for the detail stacked-die parts.

Functional Diagram

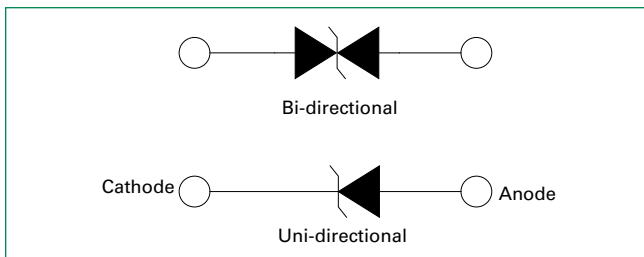

Descriptions

The 1.5SMC series is designed specifically to protect sensitive electronic equipment from voltage transients induced by lightning and other transient voltage events.

Features

- 1500W peak pulse power capability at 10/1000µs waveform, repetition rate (duty cycles):0.01 %
- Excellent clamping capability
- Low incremental surge resistance
- Typical I_R less than 1µA when V_{BR} min>12V
- For surface mounted applications to optimize board space
- Low profile package
- Built-in strain relief
- Typical failure mode is short from over-specified voltage or current
- Whisker test is conducted based on JEDEC JESD201A per its table 4a and 4c
- IEC-61000-4-2 ESD 30kV(Air), 30kV (Contact)
- ESD protection of data lines in accordance with IEC 61000-4-2
- EFT protection of data lines in accordance with IEC 61000-4-4
- Fast response time: typically less than 1.0ps from 0V to BV min
- Glass passivated chip junction
- High temperature to reflow soldering guaranteed: 260°C/40sec
- V_{BR} @ T_J = V_{BR} @ 25°C × (1 + α T × (T_J - 25)) (α T: Temperature Coefficient, typical value is 0.1%)
- Plastic package is flammability rated V-0 per Underwriters Laboratories
- Meet MSL level1, per J-STD-020, LF maximum peak of 260°C
- Matte tin lead-free plated
- Halogen free and RoHS compliant
- Pb-free E3 means 2nd level interconnect is Pb-free and the terminal finish material is tin(Sn) (IPC/JEDEC J-STD-609A.01)

Applications

TVS devices are ideal for the protection of I/O Interfaces, V_{CC} bus and other vulnerable circuits used in Telecom, Computer, Industrial and Consumer electronic applications.

Additional Information



Datasheet



Resources



Samples

Electrical Characteristics ($T_A=25^\circ\text{C}$ unless otherwise noted)

Part Number (Uni)	Part Number (Bi)	Marking		Reverse Stand off Voltage V_R (Volts)	Breakdown Voltage V_{BR} (Volts) @ I_T		Test Current I_T (mA)	Maximum Clamping Voltage V_C @ I_{PP} (V)	Maximum Peak Pulse Current I_{PP} (A)	Maximum Reverse Leakage I_R @ V_R (μA)	Agency Approval 
		Uni	Bi		Min	Max					
1.5SMC6.8A	1.5SMC6.8CA	6V8A	6V8C	5.80	6.45	7.14	10	10.5	144.8	1000	X
1.5SMC7.5A	1.5SMC7.5CA	7V5A	7V5C	6.40	7.13	7.88	10	11.3	134.5	500	X
1.5SMC8.2A	1.5SMC8.2CA	8V2A	8V2C	7.02	7.79	8.61	10	12.1	125.6	200	X
1.5SMC9.1A	1.5SMC9.1CA	9V1A	9V1C	7.78	8.65	9.50	1	13.4	113.4	50	X
1.5SMC10A	1.5SMC10CA	10A	10C	8.55	9.50	10.50	1	14.5	104.8	10	X
1.5SMC11A	1.5SMC11CA	11A	11C	9.40	10.50	11.60	1	15.6	97.4	5	X
1.5SMC12A	1.5SMC12CA	12A	12C	10.20	11.40	12.60	1	16.7	91.0	5	X
1.5SMC13A	1.5SMC13CA	13A	13C	11.10	12.40	13.70	1	18.2	83.5	1	X
1.5SMC15A	1.5SMC15CA	15A	15C	12.80	14.30	15.80	1	21.2	71.7	1	X
1.5SMC16A	1.5SMC16CA	16A	16C	13.60	15.20	16.80	1	22.5	67.6	1	X
1.5SMC18A	1.5SMC18CA	18A	18C	15.30	17.10	18.90	1	25.2	60.3	1	X
1.5SMC20A	1.5SMC20CA	20A	20C	17.10	19.00	21.00	1	27.7	54.9	1	X
1.5SMC22A	1.5SMC22CA	22A	22C	18.80	20.90	23.10	1	30.6	49.7	1	X
1.5SMC24A	1.5SMC24CA	24A	24C	20.50	22.80	25.20	1	33.2	45.8	1	X
1.5SMC27A	1.5SMC27CA	27A	27C	23.10	25.70	28.40	1	37.5	40.5	1	X
1.5SMC30A	1.5SMC30CA	30A	30C	25.60	28.50	31.50	1	41.4	36.7	1	X
1.5SMC33A	1.5SMC33CA	33A	33C	28.20	31.40	34.70	1	45.7	33.3	1	X
1.5SMC36A	1.5SMC36CA	36A	36C	30.80	34.20	37.80	1	49.9	30.5	1	X
1.5SMC39A	1.5SMC39CA	39A	39C	33.30	37.10	41.00	1	53.9	28.2	1	X
1.5SMC43A	1.5SMC43CA	43A	43C	36.80	40.90	45.20	1	59.3	25.6	1	X
1.5SMC47A	1.5SMC47CA	47A	47C	40.20	44.70	49.40	1	64.8	23.5	1	X
1.5SMC51A	1.5SMC51CA	51A	51C	43.60	48.50	53.60	1	70.1	21.7	1	X
1.5SMC56A	1.5SMC56CA	56A	56C	47.80	53.20	58.80	1	77.0	19.7	1	X
1.5SMC62A	1.5SMC62CA	62A	62C	53.00	58.90	65.10	1	85.0	17.9	1	X
1.5SMC68A	1.5SMC68CA	68A	68C	58.10	64.60	71.40	1	92.0	16.5	1	X
1.5SMC75A	1.5SMC75CA	75A	75C	64.10	71.30	78.80	1	103.0	14.8	1	X
1.5SMC82A	1.5SMC82CA	82A	82C	70.10	77.90	86.10	1	113.0	13.5	1	X
1.5SMC91A	1.5SMC91CA	91A	91C	77.80	86.50	95.50	1	125.0	12.2	1	X
1.5SMC100A	1.5SMC100CA	100A	100C	85.50	95.00	105.00	1	137.0	11.1	1	X
1.5SMC110A	1.5SMC110CA	110A	110C	94.00	105.00	116.00	1	152.0	10.0	1	X
1.5SMC120A	1.5SMC120CA	120A	120C	102.00	114.00	126.00	1	165.0	9.2	1	X
1.5SMC130A	1.5SMC130CA	130A	130C	111.00	124.00	137.00	1	179.0	8.5	1	X
1.5SMC150A	1.5SMC150CA	150A	150C	128.00	143.00	158.00	1	207.0	7.3	1	X
1.5SMC160A	1.5SMC160CA	160A	160C	136.00	152.00	168.00	1	219.0	6.9	1	X
1.5SMC170A	1.5SMC170CA	170A	170C	145.00	162.00	179.00	1	234.0	6.5	1	X
1.5SMC180A	1.5SMC180CA	180A	180C	154.00	171.00	189.00	1	246.0	6.2	1	X
1.5SMC200A	1.5SMC200CA	200A	200C	171.00	190.00	210.00	1	274.0	5.5	1	X
1.5SMC220A	1.5SMC220CA	220A	220C	185.00	209.00	231.00	1	328.0	4.6	1	X
1.5SMC250A	1.5SMC250CA	250A	250C	214.00	237.00	263.00	1	344.0	4.4	1	X
1.5SMC300A	1.5SMC300CA	300A	300C	256.00	285.00	315.00	1	414.0	3.7	1	X
1.5SMC350A	1.5SMC350CA	350A	350C	300.00	332.00	368.00	1	482.0	3.2	1	X
1.5SMC400A	1.5SMC400CA	400A	400C	342.00	380.00	420.00	1	548.0	2.8	1	X
1.5SMC440A	1.5SMC440CA	440A	440C	376.00	418.00	462.00	1	602.0	2.5	1	X
1.5SMC480A	1.5SMC480CA	480A	480C	408.00	456.00	504.00	1	658.0	2.3	1	X
1.5SMC510A	1.5SMC510CA	510A	510C	434.00	485.00	535.00	1	698.0	2.1	1	X
1.5SMC530A	1.5SMC530CA	530A	530C	451.00	503.50	556.50	1	725.0	2.1	1	X
1.5SMC540A	1.5SMC540CA	540A	540C	460.00	513.00	567.00	1	740.0	2.0	1	X
1.5SMC550A	1.5SMC550CA	550A	550C	468.00	522.50	577.50	1	760.0	2.0	1	X
1.5SMC600A	1.5SMC600CA	600A	600C	512.00	570.00	630.00	1	828.0	1.9	1	-

For bidirectional type having V_{BR} of 10 volts and less, the I_T limit is double.
 For parts without A, the V_{BR} is $\pm 10\%$ and V_C is 5% higher than with A parts.

I-V Curve Characteristics

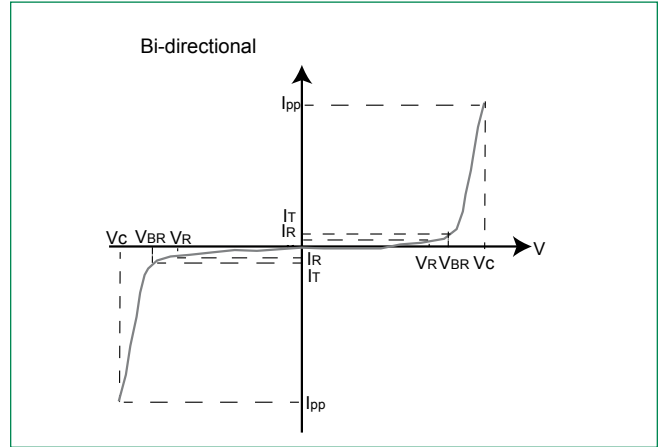
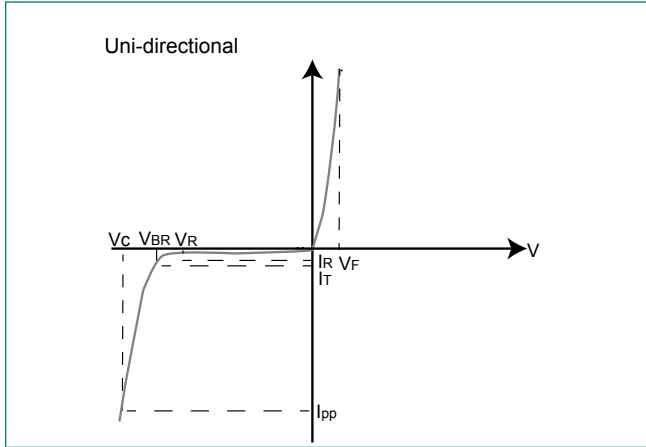

- P_{PPM}** Peak Pulse Power Dissipation -- Max power dissipation
- V_R** Stand-off Voltage -- Maximum voltage that can be applied to the TVS without operation
- V_{BR}** Breakdown Voltage -- Maximum voltage that flows through the TVS at a specified test current (I_T)
- V_c** Clamping Voltage -- Peak voltage measured across the TVS at a specified I_{ppm} (peak impulse current)
- I_R** Reverse Leakage Current -- Current measured at V_R
- V_F** Forward Voltage Drop for Uni-directional

Ratings and Characteristic Curves ($T_A=25^\circ\text{C}$ unless otherwise noted)

Figure 1 - TVS Transients Clamping Waveform

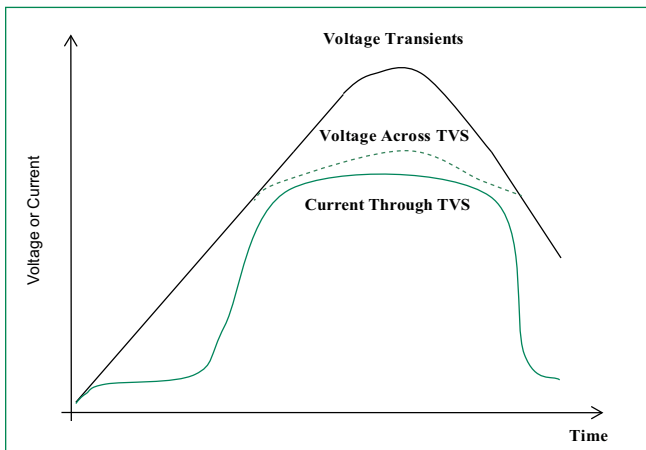
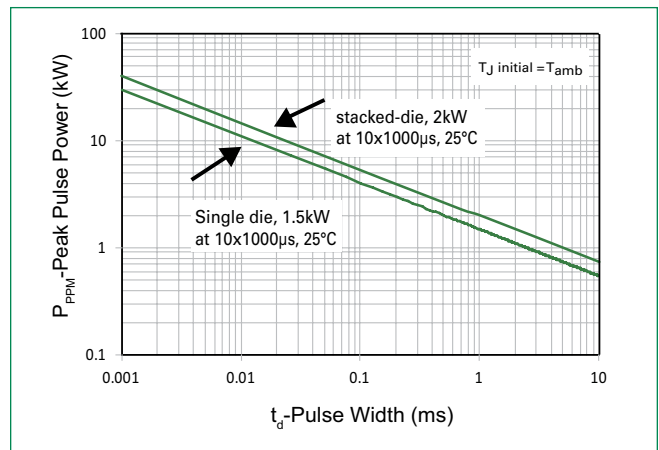

Figure 2 - Peak Pulse Power Rating



Ratings and Characteristic Curves ($T_A=25^\circ\text{C}$ unless otherwise noted) (Continued)

Figure 3 - Peak Pulse Power Derating Curve

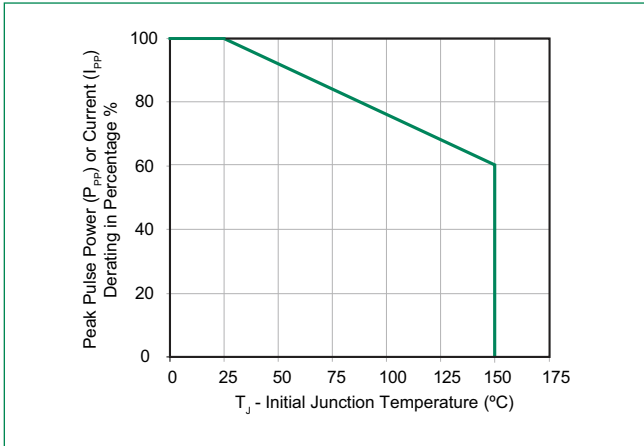

Figure 4 - Pulse Waveform

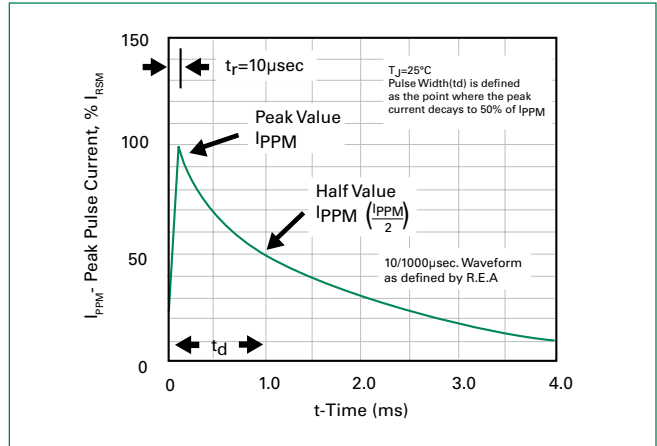

Figure 5 - Typical Junction Capacitance

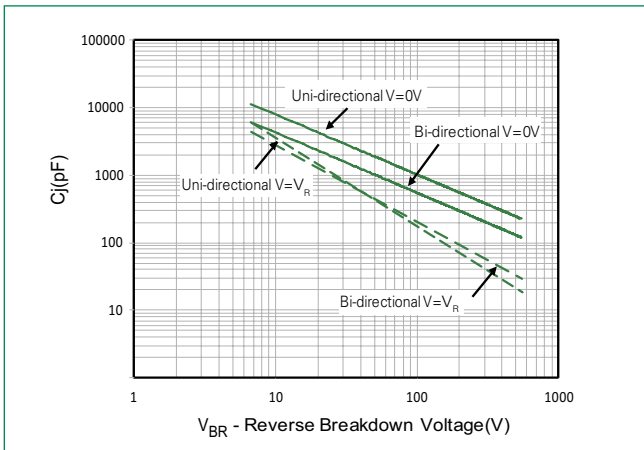

Figure 6 - Typical Transient Thermal Impedance

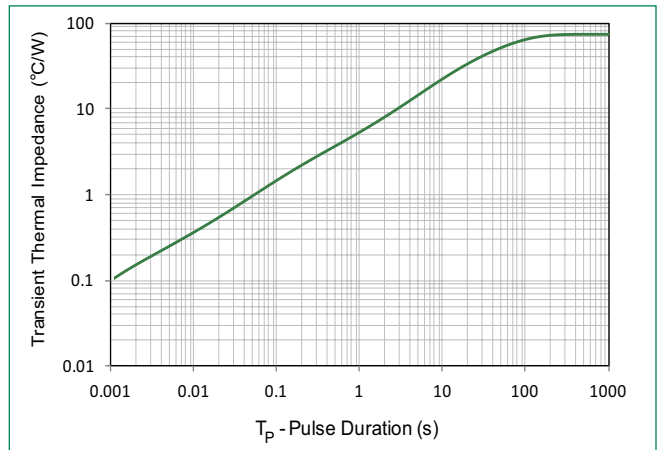

Figure 7 - Maximum Non-Repetitive Peak Forward Surge Current Uni-Directional Only

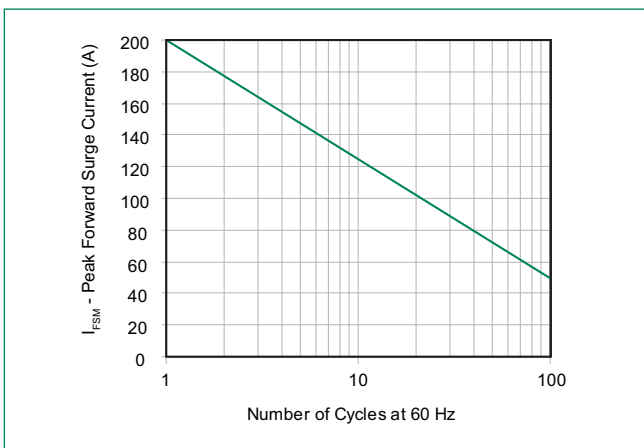
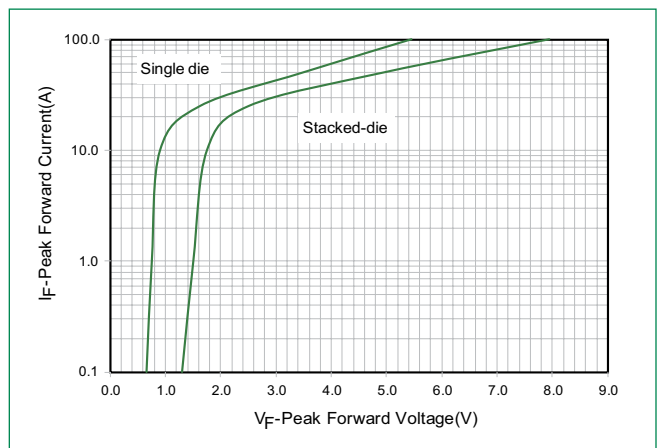
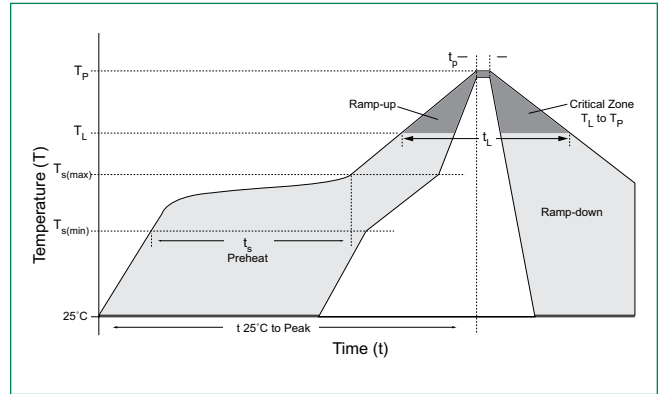

Figure 8 - Peak Forward Voltage Drop vs Peak Forward Current (Typical Values)



Soldering Parameters

Reflow Condition		Lead-free assembly
Pre Heat	- Temperature Min ($T_{s(min)}$)	150°C
	- Temperature Max ($T_{s(max)}$)	200°C
	- Time (min to max) (t_s)	60 – 180 secs
Average ramp up rate (Liquidus Temp (T_A) to peak)		3°C/second max
$T_{s(max)}$ to T_A - Ramp-up Rate		3°C/second max
Reflow	- Temperature (T_L) (Liquidus)	217°C
	- Time (min to max) (t_L)	60 – 150 seconds
Peak Temperature (T_p)		260 ^{+0/-5} °C
Time within 5°C of actual peak Temperature (t_p)		20 – 40 seconds
Ramp-down Rate		6°C/second max
Time 25°C to peak Temperature (T_p)		8 minutes Max.
Do not exceed		260°C



Physical Specifications

Weight	0.007 ounce, 0.21 grams
Case	JEDEC DO214AB. Molded plastic body over glass passivated junction
Polarity	Color band denotes positive end (cathode) except Bidirectional.
Terminal	Matte Tin-plated leads, Solderable per JESD22-B102

Environmental Specifications

High Temp. Storage	JESD22-A103
HTRB	JESD22-A108
Temperature Cycling	JESD22-A104
MSL	JEDEC-J-STD-020, Level 1
H3TRB	JESD22-A101
RSH	JESD22-A111

Dimensions

DO-214AB (SMC J-Bend)

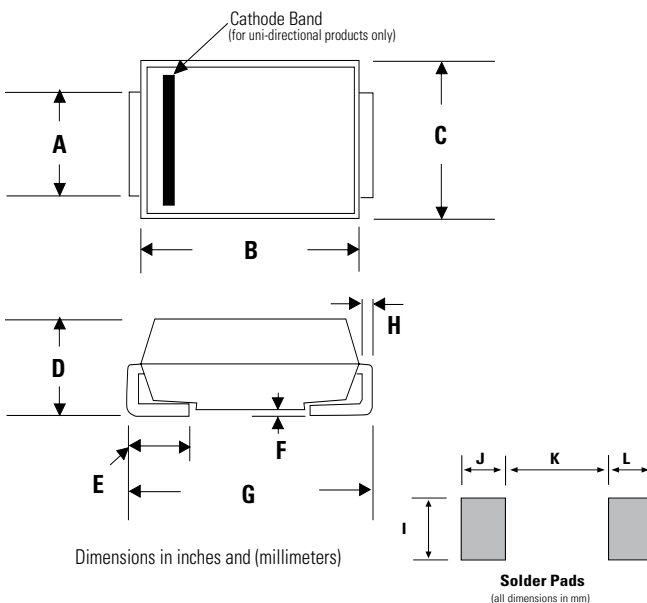

Dimensions	Inches		Millimeters	
	Min	Max	Min	Max
A	0.114	0.126	2.900	3.200
B	0.260	0.280	6.600	7.110
C	0.220	0.245	5.590	6.220
D	0.079	0.103	2.060	2.620
E	0.030	0.060	0.760	1.520
F	-	0.008	-	0.203
G	0.305	0.320	7.750	8.130
H	0.006	0.012	0.152	0.305
I	0.129	-	3.300	-
J	0.094	-	2.400	-
K	-	0.165	-	4.200
L	0.094	-	2.400	-

Part Numbering System

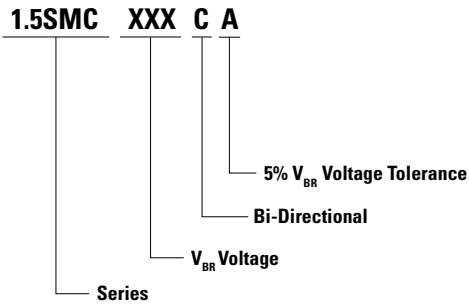

Part Marking System



Packaging

Part number	Component Package	Quantity	Packaging Option	Packaging Specification
1.5SMCxxxXX	DO-214AB	3000	Tape & Reel - 16mm tape/13" reel	EIA STD RS-481

Tape and Reel Specification

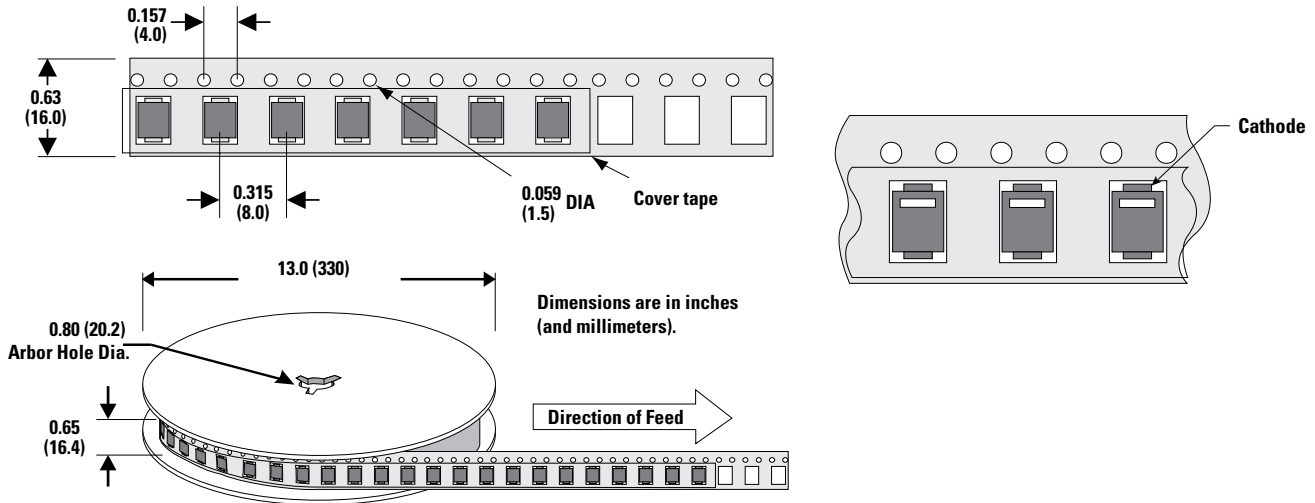

Mouser Electronics

Authorized Distributor

Click to View Pricing, Inventory, Delivery & Lifecycle Information:

Littelfuse:

[1.5SMC27CA](#) [1.5SMC220C](#) [1.5SMC24CA](#) [1.5SMC220](#) [1.5SMC440CA](#) [1.5SMC170C](#) [1.5SMC62C](#) [1.5SMC110CA](#)
[1.5SMC82C](#) [1.5SMC480](#) [1.5SMC20](#) [1.5SMC33CA](#) [1.5SMC9.1A](#) [1.5SMC550CA](#) [1.5SMC100CA](#) [1.5SMC120](#)
[1.5SMC22A](#) [1.5SMC13](#) [1.5SMC82A](#) [1.5SMC100A](#) [1.5SMC24A](#) [1.5SMC39A](#) [1.5SMC400A](#) [1.5SMC12C](#)
[1.5SMC350A](#) [1.5SMC27C](#) [1.5SMC30CA](#) [1.5SMC200CA](#) [1.5SMC200A](#) [1.5SMC220CA](#) [1.5SMC16](#) [1.5SMC91](#)
[1.5SMC120C](#) [1.5SMC43C](#) [1.5SMC18CA](#) [1.5SMC15CA](#) [1.5SMC130A](#) [1.5SMC9.1](#) [1.5SMC82](#) [1.5SMC10](#)
[1.5SMC16C](#) [1.5SMC13A](#) [1.5SMC120A](#) [1.5SMC510C](#) [1.5SMC51](#) [1.5SMC6.8A](#) [1.5SMC540](#) [1.5SMC170](#)
[1.5SMC15C](#) [1.5SMC68C](#) [1.5SMC12A](#) [1.5SMC36CA](#) [1.5SMC12CA](#) [1.5SMC200](#) [1.5SMC510](#) [1.5SMC550](#)
[1.5SMC11](#) [1.5SMC27A](#) [1.5SMC18](#) [1.5SMC13CA](#) [1.5SMC11A](#) [1.5SMC510CA](#) [1.5SMC33](#) [1.5SMC480CA](#)
[1.5SMC160](#) [1.5SMC180C](#) [1.5SMC16CA](#) [1.5SMC43A](#) [1.5SMC110C](#) [1.5SMC10CA](#) [1.5SMC11C](#) [1.5SMC540CA](#)
[1.5SMC350CA](#) [1.5SMC250](#) [1.5SMC30C](#) [1.5SMC170A](#) [1.5SMC56A](#) [1.5SMC75C](#) [1.5SMC480C](#) [1.5SMC33A](#)
[1.5SMC530](#) [1.5SMC9.1CA](#) [1.5SMC110A](#) [1.5SMC160A](#) [1.5SMC550C](#) [1.5SMC47](#) [1.5SMC75](#) [1.5SMC150C](#)
[1.5SMC20C](#) [1.5SMC400](#) [1.5SMC20CA-CT7](#) [1.5SMC11CA](#) [1.5SMC51CA](#) [1.5SMC18A](#) [1.5SMC130CA](#) [1.5SMC51A](#)
[1.5SMC160C](#) [1.5SMC47A](#) [1.5SMC8.2CA](#) [1.5SMC20A](#)