

High Efficiency Thyristor

$$V_{RRM} = 1200 \text{ V}$$

$$I_{TAV} = 50 \text{ A}$$

$$V_T = 1.27 \text{ V}$$

Single Thyristor

Part number

CLA50E1200HB



Backside: anode

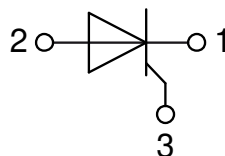

Features / Advantages:

- Thyristor for line frequency
- Planar passivated chip
- Long-term stability

Applications:

- Line rectifying 50/60 Hz
- Softstart AC motor control
- DC Motor control
- Power converter
- AC power control
- Lighting and temperature control

Package: TO-247

- Industry standard outline
- RoHS compliant
- Epoxy meets UL 94V-0

Terms and Conditions of Usage

The data contained in this product data sheet is exclusively intended for technically trained staff. The user will have to evaluate the suitability of the product for the intended application and the completeness of the product data with respect to his application. The specifications of our components may not be considered as an assurance of component characteristics. The information in the valid application- and assembly notes must be considered. Should you require product information in excess of the data given in this product data sheet or which concerns the specific application of your product, please contact your local sales office.

Due to technical requirements our product may contain dangerous substances. For information on the types in question please contact your local sales office.

Should you intend to use the product in aviation, in health or life endangering or life support applications, please notify. For any such application we urgently recommend

- to perform joint risk and quality assessments;

- the conclusion of quality agreements;

- to establish joint measures of an ongoing product survey, and that we may make delivery dependent on the realization of any such measures.

Thyristor			Ratings			
Symbol	Definition	Conditions	min.	typ.	max.	Unit
$V_{RSM/DSM}$	max. non-repetitive reverse/forward blocking voltage	$T_{VJ} = 25^{\circ}\text{C}$			1300	V
$V_{RRM/DRM}$	max. repetitive reverse/forward blocking voltage	$T_{VJ} = 25^{\circ}\text{C}$			1200	V
I_{RD}	reverse current, drain current	$V_{R/D} = 1200\text{ V}$	$T_{VJ} = 25^{\circ}\text{C}$		50	μA
		$V_{R/D} = 1200\text{ V}$	$T_{VJ} = 125^{\circ}\text{C}$		4	mA
V_T	forward voltage drop	$I_T = 50\text{ A}$	$T_{VJ} = 25^{\circ}\text{C}$		1.32	V
		$I_T = 100\text{ A}$			1.60	V
		$I_T = 50\text{ A}$	$T_{VJ} = 125^{\circ}\text{C}$		1.27	V
		$I_T = 100\text{ A}$			1.65	V
I_{TAV}	average forward current	$T_C = 125^{\circ}\text{C}$	$T_{VJ} = 150^{\circ}\text{C}$		50	A
$I_{T(RMS)}$	RMS forward current	180° sine			79	A
V_{T0}	threshold voltage	} for power loss calculation only	$T_{VJ} = 150^{\circ}\text{C}$		0.88	V
r_T	slope resistance				7.7	m Ω
R_{thJC}	thermal resistance junction to case				0.25	K/W
R_{thCH}	thermal resistance case to heatsink			0.25		K/W
P_{tot}	total power dissipation		$T_C = 25^{\circ}\text{C}$		500	W
I_{TSM}	max. forward surge current	$t = 10\text{ ms}; (50\text{ Hz}), \text{ sine}$	$T_{VJ} = 45^{\circ}\text{C}$		650	A
		$t = 8,3\text{ ms}; (60\text{ Hz}), \text{ sine}$	$V_R = 0\text{ V}$		700	A
		$t = 10\text{ ms}; (50\text{ Hz}), \text{ sine}$	$T_{VJ} = 150^{\circ}\text{C}$		555	A
		$t = 8,3\text{ ms}; (60\text{ Hz}), \text{ sine}$	$V_R = 0\text{ V}$		595	A
I^2t	value for fusing	$t = 10\text{ ms}; (50\text{ Hz}), \text{ sine}$	$T_{VJ} = 45^{\circ}\text{C}$		2.12	kA ² s
		$t = 8,3\text{ ms}; (60\text{ Hz}), \text{ sine}$	$V_R = 0\text{ V}$		2.04	kA ² s
		$t = 10\text{ ms}; (50\text{ Hz}), \text{ sine}$	$T_{VJ} = 150^{\circ}\text{C}$		1.54	kA ² s
		$t = 8,3\text{ ms}; (60\text{ Hz}), \text{ sine}$	$V_R = 0\text{ V}$		1.48	kA ² s
C_J	junction capacitance	$V_R = 400\text{ V}$ $f = 1\text{ MHz}$	$T_{VJ} = 25^{\circ}\text{C}$		25	pF
P_{GM}	max. gate power dissipation	$t_p = 30\text{ }\mu\text{s}$	$T_C = 150^{\circ}\text{C}$		10	W
		$t_p = 300\text{ }\mu\text{s}$			5	W
P_{GAV}	average gate power dissipation				0.5	W
$(di/dt)_{cr}$	critical rate of rise of current	$T_{VJ} = 150^{\circ}\text{C}; f = 50\text{ Hz}$ repetitive, $I_T = 150\text{ A}$			150	A/ μs
		$t_p = 200\text{ }\mu\text{s}; di_G/dt = 0.3\text{ A}/\mu\text{s};$ $I_G = 0.3\text{ A}; V = \frac{2}{3} V_{DRM}$ non-repet., $I_T = 50\text{ A}$			500	A/ μs
$(dv/dt)_{cr}$	critical rate of rise of voltage	$V = \frac{2}{3} V_{DRM}$ $R_{GK} = \infty$; method 1 (linear voltage rise)	$T_{VJ} = 150^{\circ}\text{C}$		1000	V/ μs
V_{GT}	gate trigger voltage	$V_D = 6\text{ V}$	$T_{VJ} = 25^{\circ}\text{C}$		1.5	V
			$T_{VJ} = -40^{\circ}\text{C}$		1.6	V
I_{GT}	gate trigger current	$V_D = 6\text{ V}$	$T_{VJ} = 25^{\circ}\text{C}$		50	mA
			$T_{VJ} = -40^{\circ}\text{C}$		80	mA
V_{GD}	gate non-trigger voltage	$V_D = \frac{2}{3} V_{DRM}$	$T_{VJ} = 150^{\circ}\text{C}$		0.2	V
I_{GD}	gate non-trigger current				3	mA
I_L	latching current	$t_p = 10\text{ }\mu\text{s}$	$T_{VJ} = 25^{\circ}\text{C}$		125	mA
		$I_G = 0.3\text{ A}; di_G/dt = 0.3\text{ A}/\mu\text{s}$				
I_H	holding current	$V_D = 6\text{ V}$ $R_{GK} = \infty$	$T_{VJ} = 25^{\circ}\text{C}$		100	mA
t_{gd}	gate controlled delay time	$V_D = \frac{1}{2} V_{DRM}$	$T_{VJ} = 25^{\circ}\text{C}$		2	μs
		$I_G = 0.3\text{ A}; di_G/dt = 0.3\text{ A}/\mu\text{s}$				
t_q	turn-off time	$V_R = 100\text{ V}; I_T = 50\text{ A}; V = \frac{2}{3} V_{DRM}$ $di/dt = 10\text{ A}/\mu\text{s}$ $dv/dt = 20\text{ V}/\mu\text{s}$ $t_p = 200\text{ }\mu\text{s}$	$T_{VJ} = 125^{\circ}\text{C}$		200	μs

Package TO-247			Ratings			
Symbol	Definition	Conditions	min.	typ.	max.	Unit
I_{RMS}	RMS current	per terminal			70	A
T_{VJ}	virtual junction temperature		-40		150	°C
T_{op}	operation temperature		-40		125	°C
T_{stg}	storage temperature		-40		150	°C
Weight				6		g
M_D	mounting torque		0.8		1.2	Nm
F_C	mounting force with clip		20		120	N

Product Marking

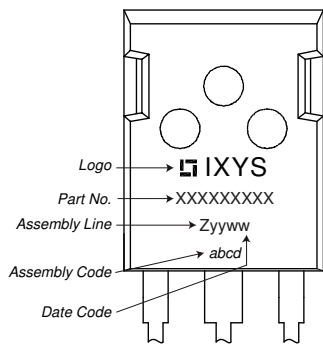

Part description

- C = Thyristor (SCR)
- L = High Efficiency Thyristor
- A = (up to 1200V)
- 50 = Current Rating [A]
- E = Single Thyristor
- 1200 = Reverse Voltage [V]
- HB = TO-247AD (3)

Ordering	Ordering Number	Marking on Product	Delivery Mode	Quantity	Code No.
Standard	CLA50E1200HB	CLA50E1200HB	Tube	30	503748

Similar Part	Package	Voltage class
CLA50E1200TC	TO-268AA (D3Pak) (2)	1200

Equivalent Circuits for Simulation

* on die level

$T_{VJ} = 150\text{ °C}$

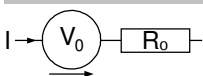

Thyristor

$V_{0\ max}$	threshold voltage	0.88	V
$R_{0\ max}$	slope resistance *	5.2	mΩ

Outlines TO-247

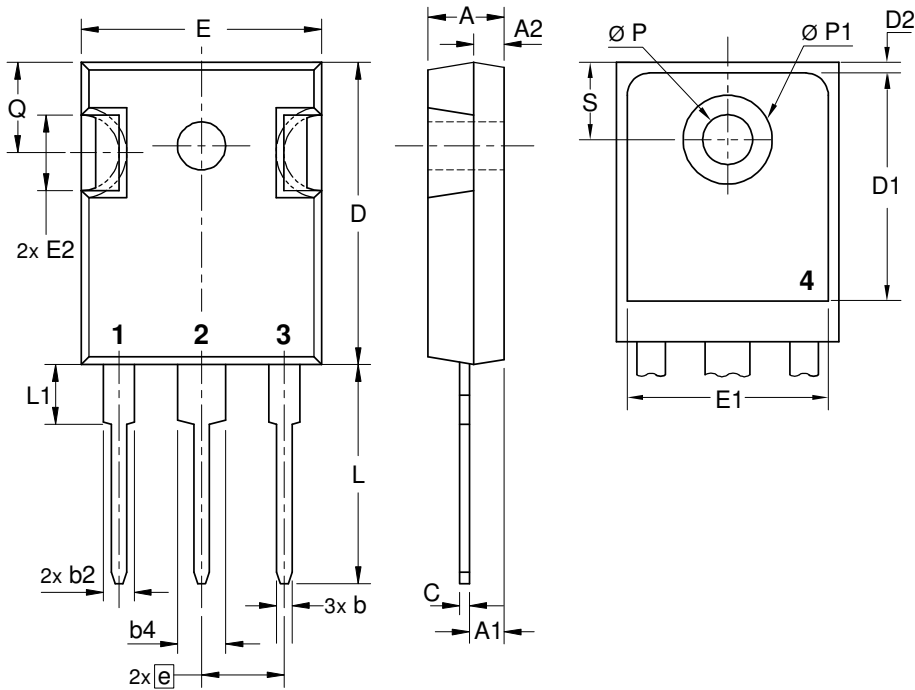

Sym.	Inches		Millimeter	
	min.	max.	min.	max.
A	0.185	0.209	4.70	5.30
A1	0.087	0.102	2.21	2.59
A2	0.059	0.098	1.50	2.49
D	0.819	0.845	20.79	21.45
E	0.610	0.640	15.48	16.24
E2	0.170	0.216	4.31	5.48
e	0.215 BSC		5.46 BSC	
L	0.780	0.800	19.80	20.30
L1	-	0.177	-	4.49
Ø P	0.140	0.144	3.55	3.65
Q	0.212		5.38	
S	0.242 BSC		6.14 BSC	
b	0.039	0.055	0.99	1.40
b2	0.065	0.094	1.65	2.39
b4	0.102	0.135	2.59	3.43
c	0.015	0.035	0.38	0.89
D1	0.515	-	13.07	-
D2	0.020	0.053	0.51	1.35
E1	0.530	-	13.45	-
Ø P1	-	0.29	-	7.39

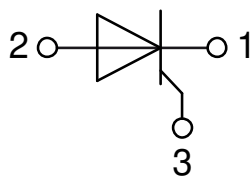

Thyristor

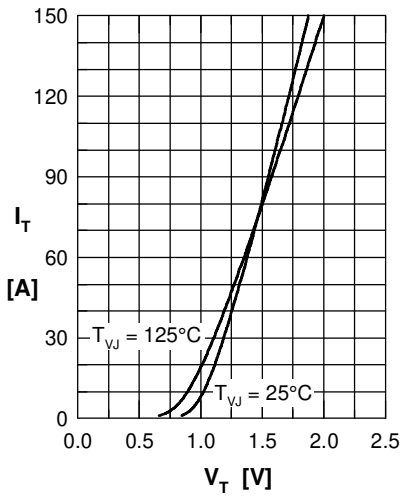

Fig. 1 Forward characteristics

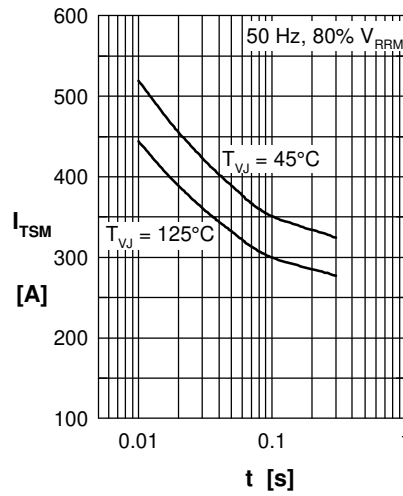

Fig. 2 Surge overload current
 I_{TSM} : crest value, t : duration

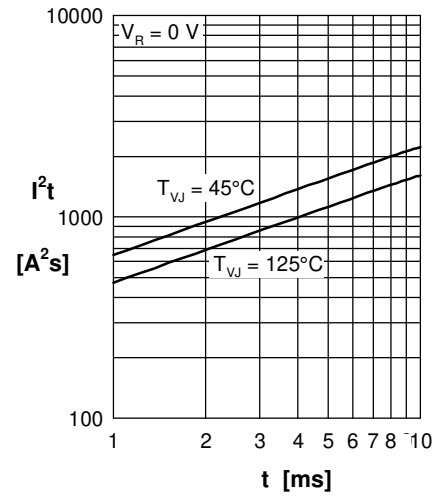

Fig. 3 I^2t versus time (1-10 s)

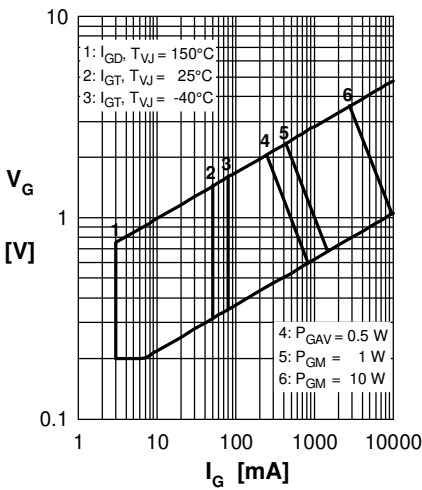

Fig. 4 Gate voltage & gate current

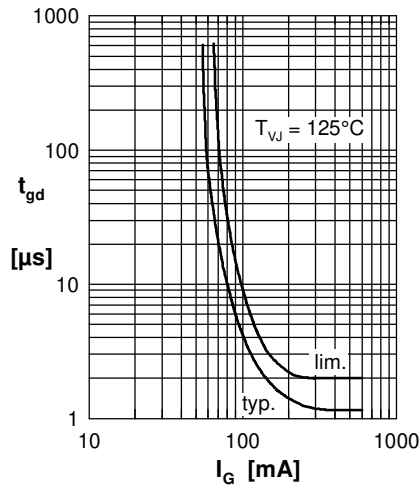

Fig. 5 Gate controlled delay time t_{gd}

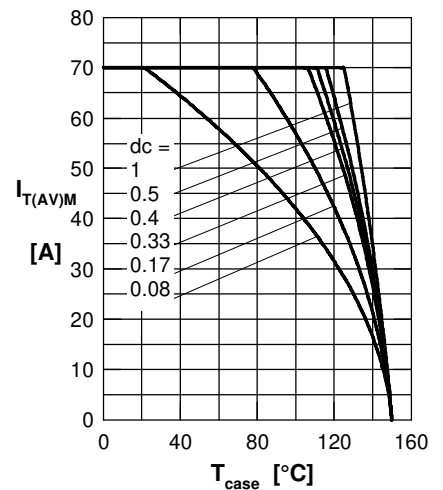

Fig. 6 Max. forward current at case temperature

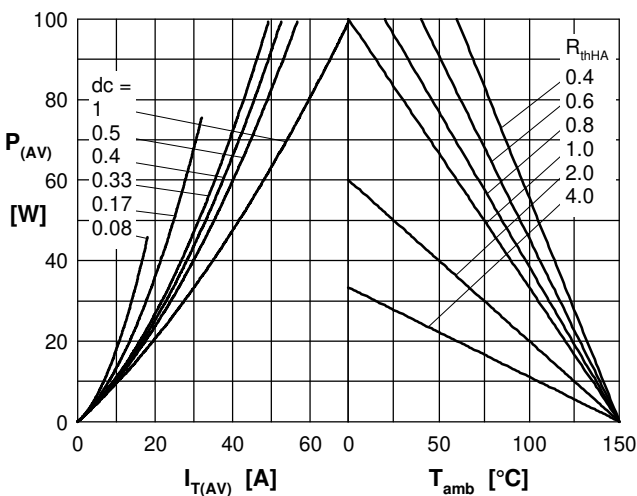

Fig. 7a Power dissipation versus direct output current
 Fig. 7b and ambient temperature

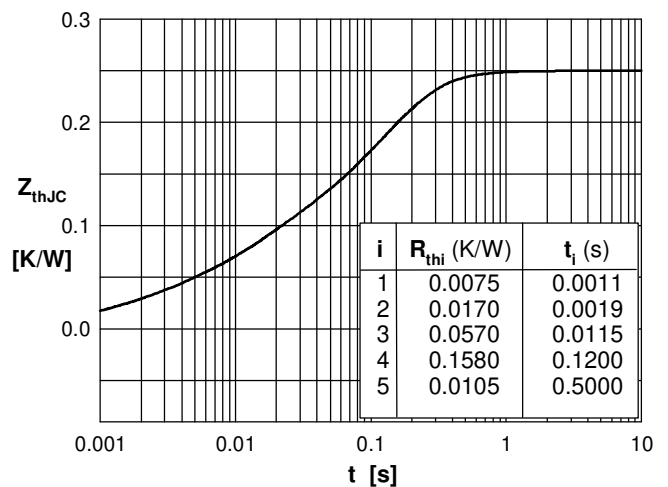

Fig. 7 Transient thermal impedance junction to case