

SC-74 Quad ESD and Surge Protector

Surge Protection Up to 350 W Peak Power

SMS05T1 Series

This quad monolithic silicon ESD and Surge Protector is designed for applications requiring ESD protection. It is intended for use in voltage and ESD sensitive equipment such as computers, printers, business machines, communication systems and other applications. This quad device provides superior surge protection over current quad Zener MMQA series by providing up to 350 watts peak power.

Features

- SC-74 Package Allows Four Separate Unidirectional Configurations
- Peak Power – 350 W, 8 x 20 μ s
- ESD Rating of Class N (Exceeding 25 kV) per the Human Body Model
- ESD Rating:
 - IEC 61000-4-2 (ESD) 15 kV (Air) 8 kV (Contact)
 - IEC 61000-4-4 (EFT) 40 A (5/5 ns)
 - IEC 61000-4-5 (Surge) 23 A (8/20 μ s)
- UL Flammability Rating of 94 V-0
- These Devices are Pb-Free and are RoHS Compliant
- SZ Prefix for Automotive and Other Applications Requiring Unique Site and Control Change Requirements; AEC-Q101 Qualified and PPAP Capable

Typical Applications

- Hand Held Portable Applications such as Cell Phones, Pagers, Notebooks and Notebook Computers

MAXIMUM RATINGS

Rating	Symbol	Value	Unit
Peak Power Dissipation 8 x 20 μ s @ $T_A = 25^\circ\text{C}$ (Note 1)	P_{pk}	350	W
Total Power Dissipation on FR-5 Board @ $T_A = 25^\circ\text{C}$ (Note 2) Derate Above 25°C	P_D	225 1.8	mW mW/ $^\circ\text{C}$
Thermal Resistance, Junction-to-Ambient	$R_{\theta JA}$	556	$^\circ\text{C}/\text{W}$
Junction and Storage Temperature Range	T_J, T_{stg}	-55 to +150	$^\circ\text{C}$
Lead Solder Temperature Maximum 10 Seconds Duration	T_L	260	$^\circ\text{C}$

Stresses exceeding those listed in the Maximum Ratings table may damage the device. If any of these limits are exceeded, device functionality should not be assumed, damage may occur and reliability may be affected.

1. Non-repetitive current pulse 8 x 20 μ s exponential decay waveform.
2. FR-5 = 1.0 x 0.75 x 0.62 in.



ON Semiconductor®

www.onsemi.com

SC-74 QUAD ESD AND SURGE PROTECTOR 350 WATTS PEAK POWER 5 VOLTS



SC-74
CASE 318F
STYLE 1

MARKING DIAGRAM

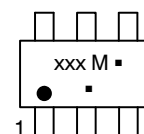

xxx = Specific Device Code
M = Date Code*
▪ = Pb-Free Package

(Note: Microdot may be in either location)
*Date Code orientation and/or position may vary depending upon manufacturing location.

PIN ASSIGNMENT

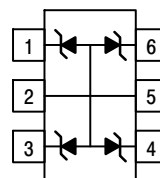

PIN 1. CATHODE
2. ANODE
3. CATHODE
4. CATHODE
5. ANODE
6. CATHODE

DEVICE MARKING INFORMATION

See specific marking information in the device marking column of the Electrical Characteristics table on page 2 of this data sheet.

ORDERING INFORMATION

See detailed ordering, marking and shipping information in the ordering information section on page 2 of this data sheet.

SMS05T1 Series

ELECTRICAL CHARACTERISTICS

(T_A = 25°C unless otherwise noted)

Symbol	Parameter
I _{PP}	Maximum Reverse Peak Pulse Current
V _C	Clamping Voltage @ I _{PP}
V _{RWM}	Working Peak Reverse Voltage
I _R	Maximum Reverse Leakage Current @ V _{RWM}
V _{BR}	Breakdown Voltage @ I _T
I _T	Test Current
∅V _{BR}	Maximum Temperature Coefficient of V _{BR}
I _F	Forward Current
V _F	Forward Voltage @ I _F
Z _{ZT}	Maximum Zener Impedance @ I _{ZT}
I _{ZK}	Reverse Current
Z _{ZK}	Maximum Zener Impedance @ I _{ZK}

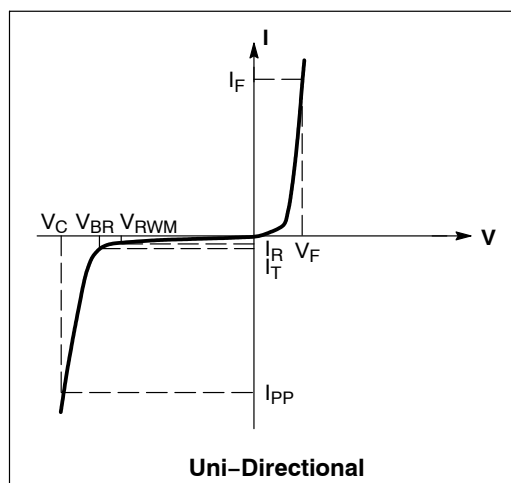

ELECTRICAL CHARACTERISTICS – UNIDIRECTIONAL

Device*	Device Marking	Breakdown Voltage			Max Reverse Leakage Current		Max Reverse Voltage (Clamping Voltage) At Specified Reverse Surge Current (I _{RSM})		Max Reverse Voltage (Clamping Voltage) At Specified Reverse Surge Current (I _{RSM})		Capacitance @ 0 Volt Bias, 1 MHz		
		V _{BR} (V)			I _T	I _R	V _R	I _{RSM} (8x20 μs)	V _{RSM} (8x20 μs)	I _{RSM} (8x20 μs)	V _{RSM} (8x20 μs)	(pF)	
		Min	Nom	Max	(mA)	(μA)	(V)	(A)	(V)	(A)	(V)	Min	Max
SMS05T1G	5V0	6.0	-	7.2	1.0	20	5.0	5.0	9.8	23	15.5	250	400
SMS12T1G	12V	13.3	-	15	1.0	1.0	12	5.0	19.0	15	23.0	80	150
SMS15T1G	15V	16.7	-	18.5	1.0	1.0	15	5.0	24.0	12	29.0	60	125
SMS24T1G	24V	26.7	-	32	1.0	1.0	24	5.0	40.0	8	44.0	40	75

*Includes SZ-prefix devices where applicable.

ORDERING INFORMATION

Device	Package	Shipping†
SMS05T1G, SZSMS05T1G**	SC-74 (Pb-Free)	3000 / Tape & Reel
SMS12T1G	SC-74 (Pb-Free)	3000 / Tape & Reel
SMS15T1G, SZSMS15T1G**	SC-74 (Pb-Free)	3000 / Tape & Reel
SMS24T1G, SZSMS24T1G**	SC-74 (Pb-Free)	3000 / Tape & Reel

†For information on tape and reel specifications, including part orientation and tape sizes, please refer to our Tape and Reel Packaging Specifications Brochure, BRD8011/D.

**SZ Prefix for Automotive and Other Applications Requiring Unique Site and Control Change Requirements; AEC-Q101 Qualified and PPAP Capable.

SMS05T1 Series

TYPICAL CHARACTERISTICS

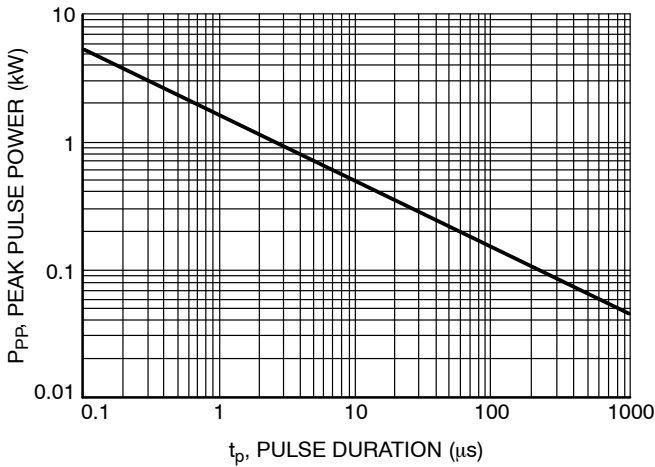

Figure 1. Non-Repetitive Peak Pulse Power versus Pulse Time

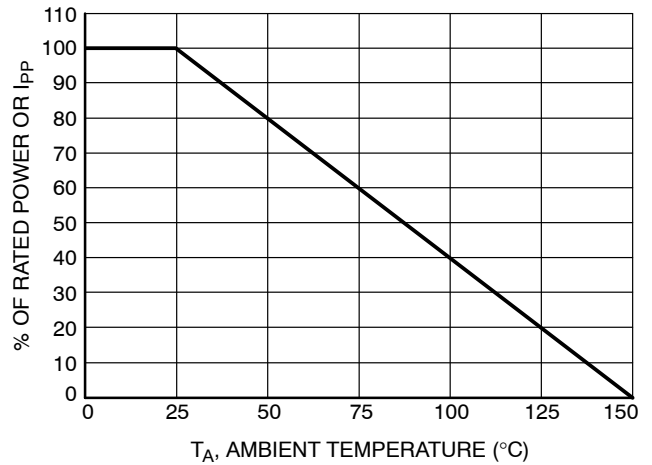

Figure 2. Power Derating Curve

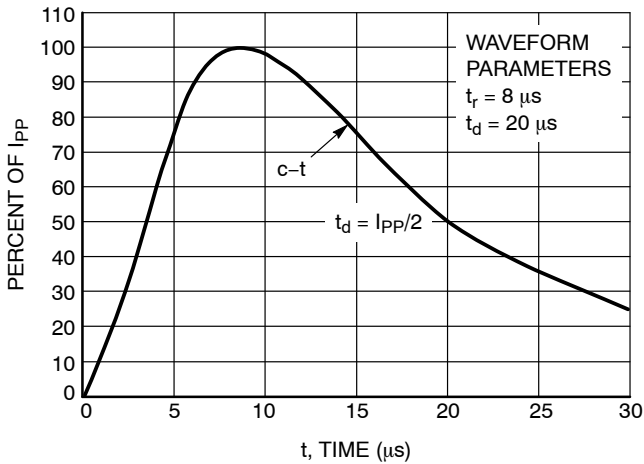

Figure 3. Pulse Waveform

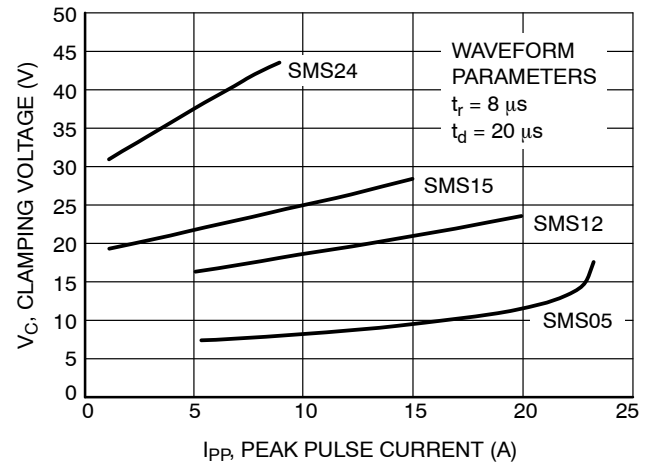

Figure 4. Clamping Voltage versus Peak Pulse Current

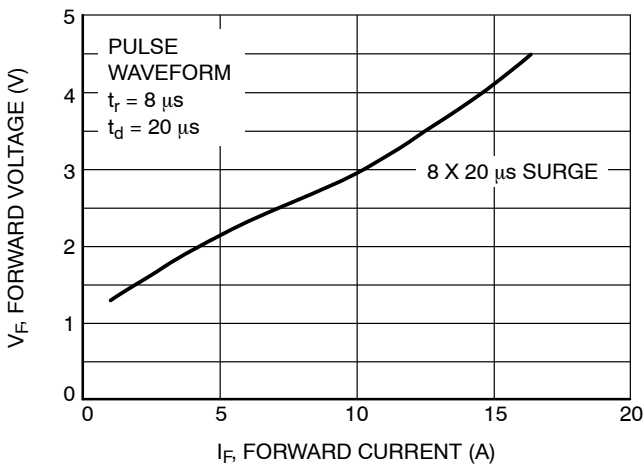

Figure 5. 8 x 20 μs V_F

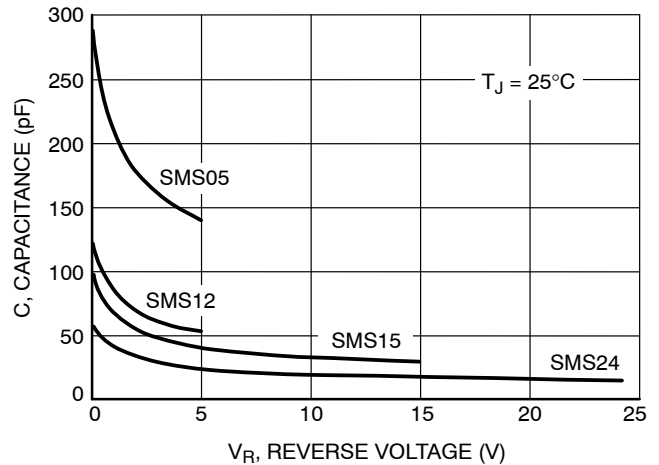

Figure 6. Typical Capacitance (SMS05 Series)

MECHANICAL CASE OUTLINE PACKAGE DIMENSIONS



SCALE 2:1

SC-74
CASE 318F
ISSUE P

DATE 07 OCT 2021

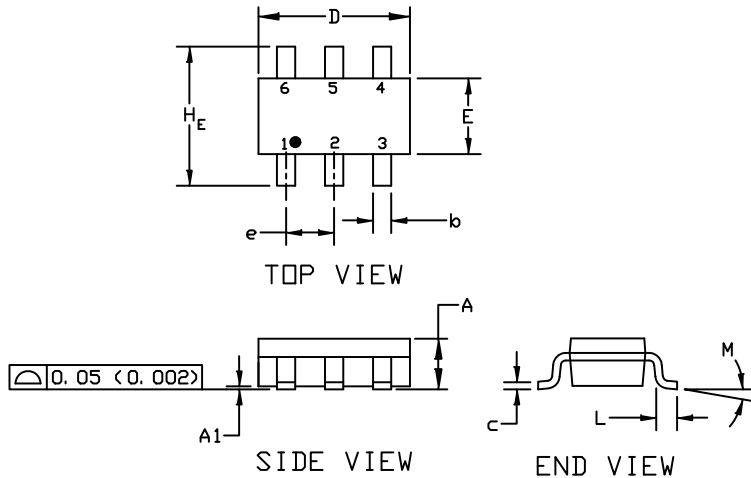

NOTES:

1. DIMENSIONING AND TOLERANCING PER ASME Y14.5M, 1994
2. CONTROLLING DIMENSION: INCHES
3. MAXIMUM LEAD THICKNESS INCLUDES LEAD FINISH THICKNESS. MINIMUM LEAD THICKNESS IS THE MINIMUM THICKNESS OF THE BASE MATERIAL.

DIM	MILLIMETERS			INCHES		
	MIN.	NOM.	MAX.	MIN.	NOM.	MAX.
A	0.90	1.00	1.10	0.035	0.039	0.043
A1	0.01	0.06	0.10	0.001	0.002	0.004
b	0.25	0.37	0.50	0.010	0.015	0.020
c	0.10	0.18	0.26	0.004	0.007	0.010
D	2.90	3.00	3.10	0.114	0.118	0.122
E	1.30	1.50	1.70	0.051	0.059	0.067
e	0.85	0.95	1.05	0.034	0.037	0.041
HE	2.50	2.75	3.00	0.099	0.108	0.118
L	0.20	0.40	0.60	0.008	0.016	0.024
M	0*	---	10*	0*	---	10*

GENERIC MARKING DIAGRAM*

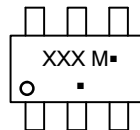

- XXX = Specific Device Code
- M = Date Code
- = Pb-Free Package

(Note: Microdot may be in either location)

*This information is generic. Please refer to device data sheet for actual part marking. Pb-Free indicator, "G" or microdot "▪", may or may not be present. Some products may not follow the Generic Marking.

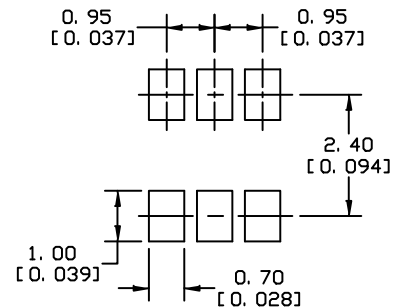

* For additional information on our Pb-Free strategy and soldering details, please download the DN Semiconductor Soldering and Mounting Techniques Reference Manual, SOLDERM/D.

SOLDERING FOOTPRINT

- | | | | | | |
|---|--|---|--|---|---|
| <p>STYLE 1:
PIN 1. CATHODE
2. ANODE
3. CATHODE
4. CATHODE
5. ANODE
6. CATHODE</p> | <p>STYLE 2:
PIN 1. NO CONNECTION
2. COLLECTOR
3. EMITTER
4. NO CONNECTION
5. COLLECTOR
6. BASE</p> | <p>STYLE 3:
PIN 1. EMITTER 1
2. BASE 1
3. COLLECTOR 2
4. EMITTER 2
5. BASE 2
6. COLLECTOR 1</p> | <p>STYLE 4:
PIN 1. COLLECTOR 2
2. EMITTER 1/EMITTER 2
3. COLLECTOR 1
4. EMITTER 3
5. BASE 1/BASE 2/COLLECTOR 3
6. BASE 3</p> | <p>STYLE 5:
PIN 1. CHANNEL 1
2. ANODE
3. CHANNEL 2
4. CHANNEL 3
5. CATHODE
6. CHANNEL 4</p> | <p>STYLE 6:
PIN 1. CATHODE
2. ANODE
3. CATHODE
4. CATHODE
5. CATHODE
6. CATHODE</p> |
| <p>STYLE 7:
PIN 1. SOURCE 1
2. GATE 1
3. DRAIN 2
4. SOURCE 2
5. GATE 2
6. DRAIN 1</p> | <p>STYLE 8:
PIN 1. EMITTER 1
2. BASE 2
3. COLLECTOR 2
4. EMITTER 2
5. BASE 1
6. COLLECTOR 1</p> | <p>STYLE 9:
PIN 1. EMITTER 2
2. BASE 2
3. COLLECTOR 1
4. EMITTER 1
5. BASE 1
6. COLLECTOR 2</p> | <p>STYLE 10:
PIN 1. ANODE/CATHODE
2. BASE
3. EMITTER
4. COLLECTOR
5. ANODE
6. CATHODE</p> | <p>STYLE 11:
PIN 1. EMITTER
2. BASE
3. ANODE/CATHODE
4. ANODE
5. CATHODE
6. COLLECTOR</p> | |

DOCUMENT NUMBER:	98ASB42973B	Electronic versions are uncontrolled except when accessed directly from the Document Repository. Printed versions are uncontrolled except when stamped "CONTROLLED COPY" in red.
DESCRIPTION:	SC-74	PAGE 1 OF 1

onsemi and ONSEMI are trademarks of Semiconductor Components Industries, LLC dba onsemi or its subsidiaries in the United States and/or other countries. onsemi reserves the right to make changes without further notice to any products herein. onsemi makes no warranty, representation or guarantee regarding the suitability of its products for any particular purpose, nor does onsemi assume any liability arising out of the application or use of any product or circuit, and specifically disclaims any and all liability, including without limitation special, consequential or incidental damages. onsemi does not convey any license under its patent rights nor the rights of others.

onsemi, **Onsemi**, and other names, marks, and brands are registered and/or common law trademarks of Semiconductor Components Industries, LLC dba "**onsemi**" or its affiliates and/or subsidiaries in the United States and/or other countries. **onsemi** owns the rights to a number of patents, trademarks, copyrights, trade secrets, and other intellectual property. A listing of **onsemi**'s product/patent coverage may be accessed at www.onsemi.com/site/pdf/Patent-Marking.pdf. **onsemi** reserves the right to make changes at any time to any products or information herein, without notice. The information herein is provided "as-is" and **onsemi** makes no warranty, representation or guarantee regarding the accuracy of the information, product features, availability, functionality, or suitability of its products for any particular purpose, nor does **onsemi** assume any liability arising out of the application or use of any product or circuit, and specifically disclaims any and all liability, including without limitation special, consequential or incidental damages. Buyer is responsible for its products and applications using **onsemi** products, including compliance with all laws, regulations and safety requirements or standards, regardless of any support or applications information provided by **onsemi**. "Typical" parameters which may be provided in **onsemi** data sheets and/or specifications can and do vary in different applications and actual performance may vary over time. All operating parameters, including "Typicals" must be validated for each customer application by customer's technical experts. **onsemi** does not convey any license under any of its intellectual property rights nor the rights of others. **onsemi** products are not designed, intended, or authorized for use as a critical component in life support systems or any FDA Class 3 medical devices or medical devices with a same or similar classification in a foreign jurisdiction or any devices intended for implantation in the human body. Should Buyer purchase or use **onsemi** products for any such unintended or unauthorized application, Buyer shall indemnify and hold **onsemi** and its officers, employees, subsidiaries, affiliates, and distributors harmless against all claims, costs, damages, and expenses, and reasonable attorney fees arising out of, directly or indirectly, any claim of personal injury or death associated with such unintended or unauthorized use, even if such claim alleges that **onsemi** was negligent regarding the design or manufacture of the part. **onsemi** is an Equal Opportunity/Affirmative Action Employer. This literature is subject to all applicable copyright laws and is not for resale in any manner.

PUBLICATION ORDERING INFORMATION

LITERATURE FULFILLMENT:

Email Requests to: orderlit@onsemi.com

onsemi Website: www.onsemi.com

TECHNICAL SUPPORT

North American Technical Support:

Voice Mail: 1 800-282-9855 Toll Free USA/Canada

Phone: 011 421 33 790 2910

Europe, Middle East and Africa Technical Support:

Phone: 00421 33 790 2910

For additional information, please contact your local Sales Representative