

P6SMB Series

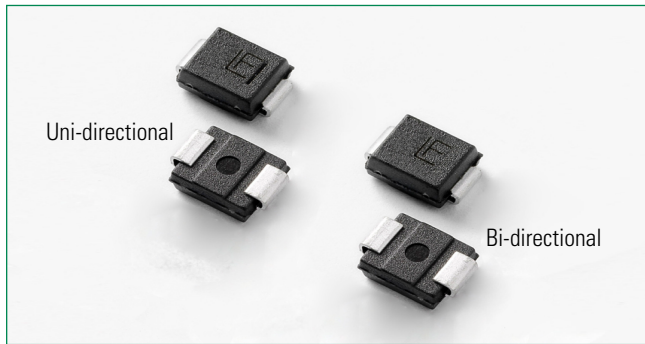

Agency Approvals

| Agency | Agency File Number |
|--------|--------------------|
| | E230531 |

Maximum Ratings and Thermal Characteristics
(T_A = 25°C unless otherwise noted)

| Parameter | Symbol | Value | Unit |
|---|------------------|------------|------|
| Peak Pulse Power Dissipation ^(Fig.2) by 10/1000us Test Waveform ^(Fig.4) (Note 1),(Note 2)-Single Die Parts | P _{PPM} | 600 | W |
| Peak Pulse Power Dissipation ^(Fig.2) by 10/1000us Test Waveform ^(Fig.4) (Note 1, Note 2)-Stacked Die Parts (Note 5) | P _{PPM} | 800 | W |
| Power Dissipation on Infinite Heat Sink at T _L =50°C | P _D | 5.0 | W |
| Peak Forward Surge Current, 8.3ms Single Half Sine Wave (Note 3) | I _{FSM} | 100 | A |
| Maximum Instantaneous Forward Voltage at 50A for Unidirectional Only (Note 4) | V _F | 3.5/5.0 | V |
| Operating Temperature Range | T _J | -65 to 150 | °C |
| Storage Temperature Range | T _{STG} | -65 to 175 | °C |
| Typical Thermal Resistance Junction to Lead | R _{θJL} | 20 | °C/W |
| Typical Thermal Resistance Junction to Ambient | R _{θJA} | 100 | °C/W |

- Notes:**
1. Non-repetitive current pulse, per Fig. 4 and derated above T_J (initial) = 25°C per Fig. 3.
 2. Mounted on copper pad area of 0.2x0.2" (5.0 x 5.0mm) to each terminal.
 3. Measured on 8.3ms single half sine wave or equivalent square wave for unidirectional device only, duty cycle=4 per minute maximum.
 4. V_F < 3.5V for single die parts and V_F < 5.0V for stacked-die parts.
 5. For stacked die component details, please refer to part numbers labeled by * in Electrical Characteristics.

Functional Diagram

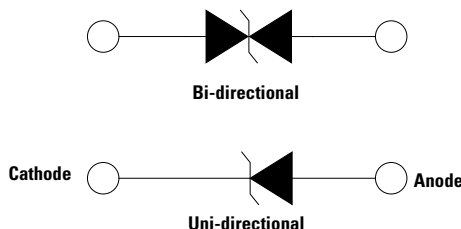

Description

The P6SMB series is designed specifically to protect sensitive electronic equipment from voltage transients induced by lightning and other transient voltage events.

Features

- 600W peak pulse power capability at 10/1000µs waveform, repetition rate (duty cycles):0.01 %
- Excellent clamping capability
- Low incremental surge resistance
- Typical I_R less than 1µA when V_{BR} min > 12V
- Optimized surface mount footprint for minimal PCB space impact
- Low profile package
- Typical failure mode due to exceeding maximum ratings is a short circuit condition
- Whisker test conducted based on Table 4a and 4c of JEDEC JESD201A
- IEC 61000-4-2 ESD 30kV(Air), 30kV (Contact)
- EFT protection of data lines in accordance with IEC 61000-4-4
- Built-in strain relief
- Fast response time: typically less than 1.0ps from 0V to V_{BR} min
- High temperature to reflow soldering guaranteed: 260°C/30sec
- V_{BR} @ T_J = V_{BR} @ 25°C x (1 + α T (T_J - 25)) (α T: Temperature Coefficient, typical value is 0.1%)
- UL Recognized compound meeting flammability classification V-0
- Meet MSL level1, per J-STD-020, LF maximum peak of 260°C
- Matte tin lead-free plated
- Halogen free and RoHS compliant
- Pb-free E3 means 2ND level interconnect is Pb-free and the terminal finish material is tin(Sn) (IPC/ JEDEC J-STD-609A.01)
- UL Recognized to ANSI/UL 497B: Protectors for Data Communications and Fire-Alarm Circuits.

Applications

TVS devices are ideal for the protection of I/O Interfaces, V_{CC} bus and other vulnerable circuits used in Telecom, Computer, Industrial and Consumer electronic applications.

Additional Information



Electrical Characteristics (T_A=25°C unless otherwise noted)

| Part Number (Uni) | Part Number (Bi) | Marking | | Reverse Stand off Voltage V _R (Volts) | Breakdown Voltage V _{BR} (Volts) @ I _T | | Test Current I _T (mA) | Maximum Clamping Voltage V _C @ I _{pp} (V) | Maximum Peak Pulse Current I _{pp} (A) | Maximum Reverse Leakage I _R @ V _R (µA) | Maximum Temperature coefficient of V _{BR} (%/°C) | Agency Approval  |
|-------------------|------------------|---------|------|--|--|--------|----------------------------------|---|--|--|---|---|
| | | UNI | BI | | MIN | MAX | | | | | | |
| | | | | | | | | | | | | |
| P6SMB6.8A | P6SMB6.8CA | 6V8A | 6V8C | 5.80 | 6.45 | 7.14 | 10 | 10.5 | 58.1 | 1000 | 0.041 | X |
| P6SMB7.5A | P6SMB7.5CA | 7V5A | 7V5C | 6.40 | 7.13 | 7.88 | 10 | 11.3 | 54.0 | 500 | 0.054 | X |
| P6SMB8.2A | P6SMB8.2CA | 8V2A | 8V2C | 7.02 | 7.79 | 8.61 | 10 | 12.1 | 50.4 | 200 | 0.058 | X |
| P6SMB9.1A | P6SMB9.1CA | 9V1A | 9V1C | 7.78 | 8.65 | 9.55 | 1 | 13.4 | 45.5 | 50 | 0.063 | X |
| P6SMB10A | P6SMB10CA | 10A | 10C | 8.55 | 9.50 | 10.50 | 1 | 14.5 | 42.1 | 10 | 0.066 | X |
| P6SMB11A | P6SMB11CA | 11A | 11C | 9.40 | 10.50 | 11.60 | 1 | 15.6 | 39.1 | 5 | 0.069 | X |
| P6SMB12A | P6SMB12CA | 12A | 12C | 10.20 | 11.40 | 12.60 | 1 | 16.7 | 36.5 | 5 | 0.071 | X |
| P6SMB13A | P6SMB13CA | 13A | 13C | 11.10 | 12.40 | 13.70 | 1 | 18.2 | 33.5 | 1 | 0.074 | X |
| P6SMB15A | P6SMB15CA | 15A | 15C | 12.80 | 14.30 | 15.80 | 1 | 21.2 | 28.8 | 1 | 0.076 | X |
| P6SMB16A | P6SMB16CA | 16A | 16C | 13.60 | 15.20 | 16.80 | 1 | 22.5 | 27.1 | 1 | 0.080 | X |
| P6SMB18A | P6SMB18CA | 18A | 18C | 15.30 | 17.10 | 18.90 | 1 | 25.5 | 24.2 | 1 | 0.083 | X |
| P6SMB20A | P6SMB20CA | 20A | 20C | 17.10 | 19.00 | 21.00 | 1 | 27.7 | 22.0 | 1 | 0.085 | X |
| P6SMB22A | P6SMB22CA | 22A | 22C | 18.80 | 20.90 | 23.10 | 1 | 30.6 | 19.9 | 1 | 0.088 | X |
| P6SMB24A | P6SMB24CA | 24A | 24C | 20.50 | 22.80 | 25.20 | 1 | 33.2 | 18.4 | 1 | 0.091 | X |
| P6SMB27A | P6SMB27CA | 27A | 27C | 23.10 | 25.70 | 28.40 | 1 | 37.5 | 16.3 | 1 | 0.092 | X |
| P6SMB30A | P6SMB30CA | 30A | 30C | 25.60 | 28.50 | 31.50 | 1 | 41.4 | 14.7 | 1 | 0.093 | X |
| P6SMB33A | P6SMB33CA | 33A | 33C | 28.20 | 31.40 | 34.70 | 1 | 45.7 | 13.3 | 1 | 0.094 | X |
| P6SMB36A | P6SMB36CA | 36A | 36C | 30.80 | 34.20 | 37.80 | 1 | 49.9 | 12.2 | 1 | 0.096 | X |
| P6SMB39A | P6SMB39CA | 39A | 39C | 33.30 | 37.10 | 41.00 | 1 | 53.9 | 11.3 | 1 | 0.097 | X |
| P6SMB43A | P6SMB43CA | 43A | 43C | 36.80 | 40.90 | 45.20 | 1 | 59.3 | 10.3 | 1 | 0.098 | X |
| P6SMB47A | P6SMB47CA | 47A | 47C | 40.20 | 44.70 | 49.40 | 1 | 64.8 | 9.4 | 1 | 0.099 | X |
| P6SMB51A | P6SMB51CA | 51A | 51C | 43.60 | 48.50 | 53.60 | 1 | 70.1 | 8.7 | 1 | 0.100 | X |
| P6SMB56A | P6SMB56CA | 56A | 56C | 47.80 | 53.20 | 58.80 | 1 | 77.0 | 7.9 | 1 | 0.101 | X |
| P6SMB58A | P6SMB58CA | 58A | 58C | 52.78 | 55.10 | 60.90 | 1 | 79.8 | 7.7 | 1 | 0.101 | - |
| P6SMB62A | P6SMB62CA | 62A | 62C | 53.00 | 58.90 | 65.10 | 1 | 85.0 | 7.2 | 1 | 0.102 | X |
| P6SMB68A | P6SMB68CA | 68A | 68C | 58.10 | 64.60 | 71.40 | 1 | 92.0 | 6.6 | 1 | 0.103 | X |
| P6SMB75A | P6SMB75CA | 75A | 75C | 64.10 | 71.30 | 78.80 | 1 | 103.0 | 5.9 | 1 | 0.104 | X |
| P6SMB82A | P6SMB82CA | 82A | 82C | 70.10 | 77.90 | 86.10 | 1 | 113.0 | 5.4 | 1 | 0.105 | X |
| P6SMB91A | P6SMB91CA | 91A | 91C | 77.80 | 86.50 | 95.50 | 1 | 125.0 | 4.9 | 1 | 0.106 | X |
| P6SMB100A | P6SMB100CA | 100A | 100C | 85.50 | 95.00 | 105.00 | 1 | 137.0 | 4.5 | 1 | 0.106 | X |
| P6SMB110A | P6SMB110CA | 110A | 110C | 94.00 | 105.00 | 116.00 | 1 | 152.0 | 4.0 | 1 | 0.107 | X |
| P6SMB120A | P6SMB120CA | 120A | 120C | 102.00 | 114.00 | 126.00 | 1 | 165.0 | 3.7 | 1 | 0.107 | X |
| P6SMB130A | P6SMB130CA | 130A | 130C | 111.00 | 124.00 | 137.00 | 1 | 179.0 | 3.4 | 1 | 0.107 | X |
| P6SMB150A | P6SMB150CA | 150A | 150C | 128.00 | 143.00 | 158.00 | 1 | 207.0 | 2.9 | 1 | 0.108 | X |
| P6SMB160A | P6SMB160CA | 160A | 160C | 136.00 | 152.00 | 168.00 | 1 | 219.0 | 2.8 | 1 | 0.108 | X |
| P6SMB170A | P6SMB170CA | 170A | 170C | 145.00 | 162.00 | 179.00 | 1 | 234.0 | 2.6 | 1 | 0.108 | X |
| P6SMB180A | P6SMB180CA | 180A | 180C | 154.00 | 171.00 | 189.00 | 1 | 246.0 | 2.5 | 1 | 0.108 | X |
| P6SMB200A | P6SMB200CA | 200A | 200C | 171.00 | 190.00 | 210.00 | 1 | 274.0 | 2.2 | 1 | 0.108 | X |
| P6SMB220A | P6SMB220CA | 220A | 220C | 185.00 | 209.00 | 231.00 | 1 | 328.0 | 1.9 | 1 | 0.110 | X |
| P6SMB250A | P6SMB250CA | 250A | 250C | 214.00 | 237.00 | 263.00 | 1 | 344.0 | 1.8 | 1 | 0.110 | X |
| P6SMB300A | P6SMB300CA | 300A | 300C | 256.00 | 285.00 | 315.00 | 1 | 414.0 | 1.5 | 1 | 0.110 | X |
| P6SMB350A* | P6SMB350CA* | 350A | 350C | 300.00 | 332.00 | 368.00 | 1 | 482.0 | 1.7 | 1 | 0.112 | X |
| P6SMB400A* | P6SMB400CA* | 400A | 400C | 342.00 | 380.00 | 420.00 | 1 | 548.0 | 1.5 | 1 | 0.112 | X |
| P6SMB440A* | P6SMB440CA* | 440A | 440C | 376.00 | 418.00 | 462.00 | 1 | 602.0 | 1.4 | 1 | 0.112 | X |
| P6SMB480A* | P6SMB480CA* | 480A | 480C | 408.00 | 456.00 | 504.00 | 1 | 658.0 | 1.3 | 1 | 0.112 | X |
| P6SMB510A* | P6SMB510CA* | 510A | 510C | 434.00 | 485.00 | 535.00 | 1 | 698.0 | 1.2 | 1 | 0.112 | X |
| P6SMB530A* | P6SMB530CA* | 530A | 530C | 451.00 | 503.50 | 556.50 | 1 | 725.0 | 1.2 | 1 | 0.112 | X |
| P6SMB540A* | P6SMB540CA* | 540A | 540C | 460.00 | 513.00 | 567.00 | 1 | 740.0 | 1.1 | 1 | 0.112 | X |
| P6SMB550A* | P6SMB550CA* | 550A | 550C | 468.00 | 522.50 | 577.50 | 1 | 760.0 | 1.1 | 1 | 0.112 | X |
| P6SMB600A* | P6SMB600CA* | 600A | 600C | 512.00 | 570.00 | 630.00 | 1 | 828.0 | 1.0 | 1 | 0.112 | - |

For bidirectional type having V_R of 10 volts and less, the I_R limit is double.
 For stack-die parts, use * to label the part number.

I-V Curve Characteristics

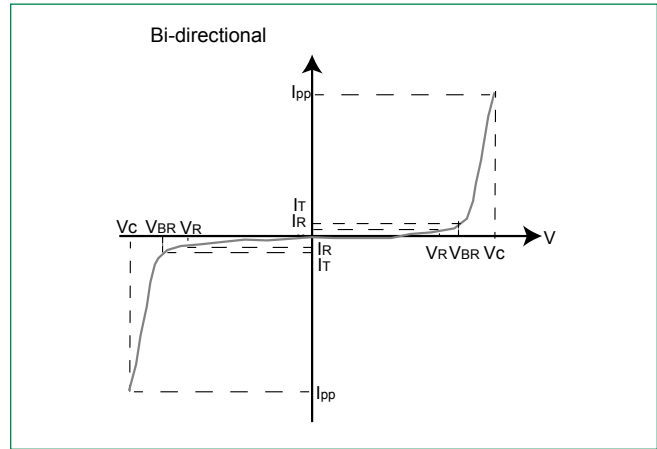
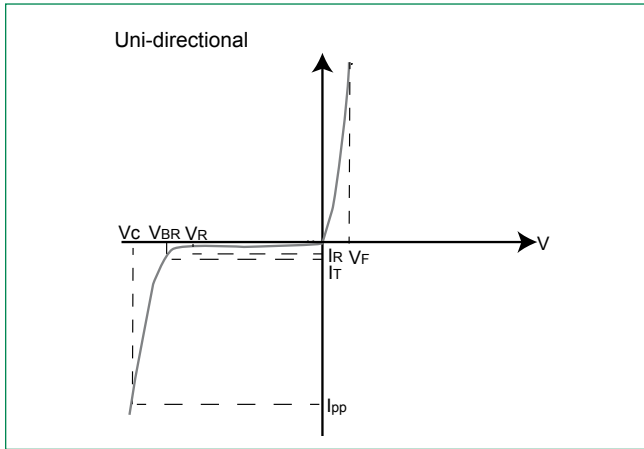

- P_{PPM} Peak Pulse Power Dissipation** – Max power dissipation ($V_C * I_{pp}$)
- V_R Stand-off Voltage** – Maximum voltage that can be applied to the TVS without operation
- V_{BR} Breakdown Voltage** – Maximum voltage that flows through the TVS at a specified test current (I_T)
- V_C Clamping Voltage** – Peak voltage measured across the TVS at a specified I_{ppm} (peak impulse current)
- I_R Reverse Leakage Current** – Current measured at V_R
- V_F Forward Voltage Drop for Uni-directional**

Ratings and Characteristic Curves ($T_A=25^\circ\text{C}$ unless otherwise noted)

Figure 1 - TVS Transients Clamping Waveform

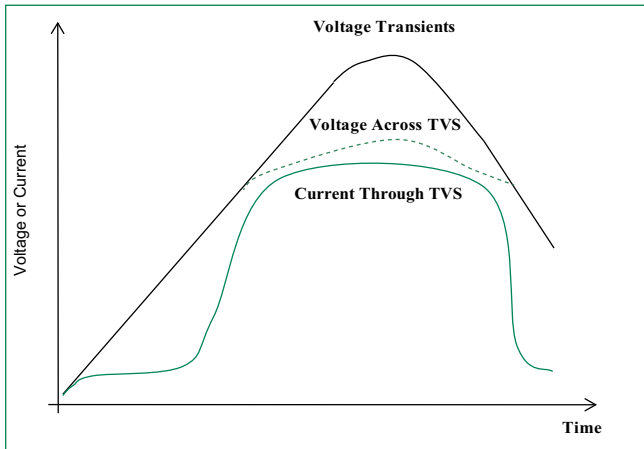
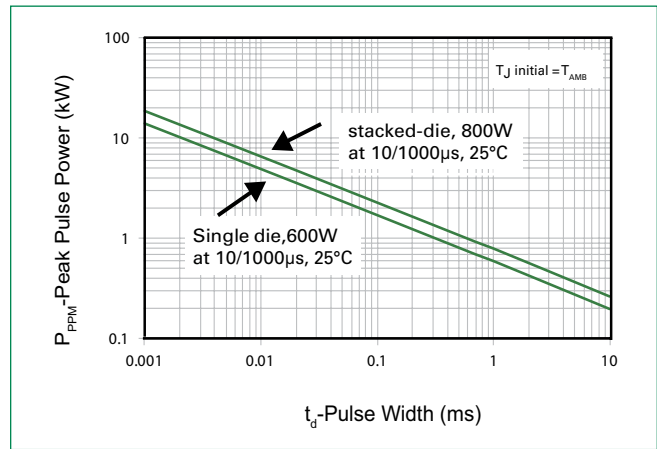

Figure 2 - Peak Pulse Power Rating



Ratings and Characteristic Curves ($T_A=25^\circ\text{C}$ unless otherwise noted) (Continued)

Figure 3 - Peak Pulse Power Derating Curve

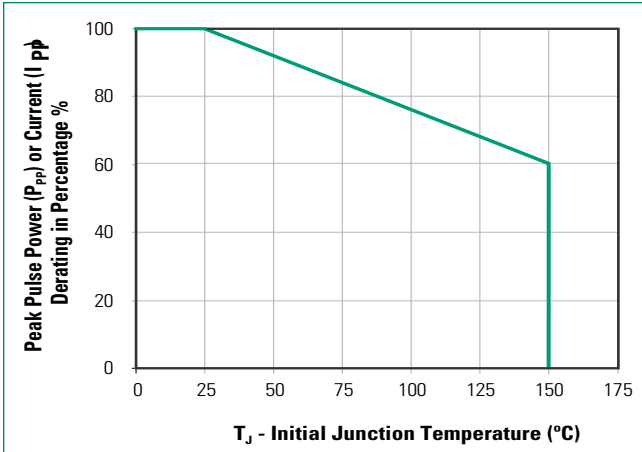

Figure 4 - Pulse Waveform

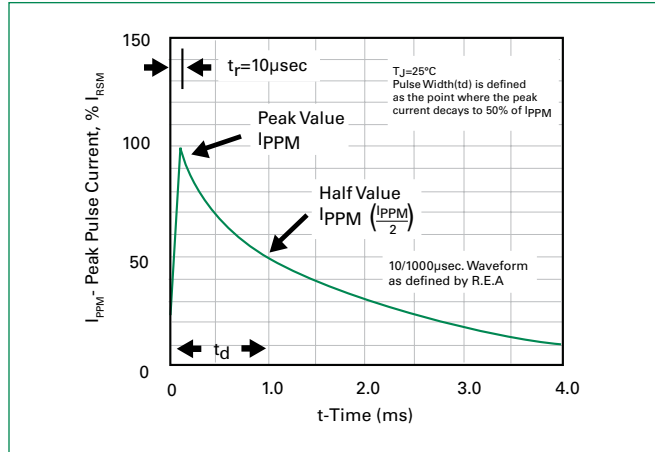

Figure 5 - Typical Junction Capacitance

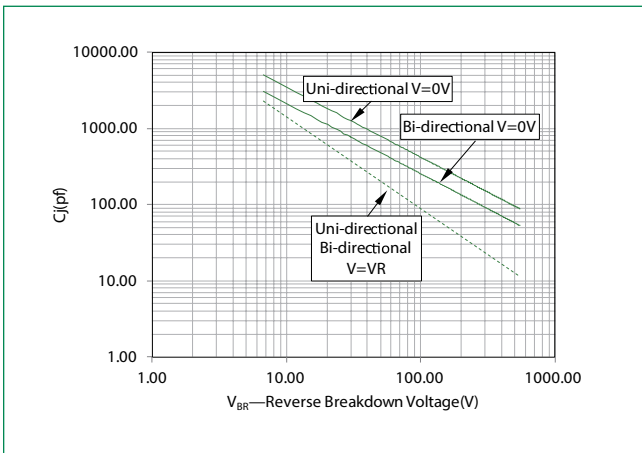

Figure 6 - Typical Transient Thermal Impedance

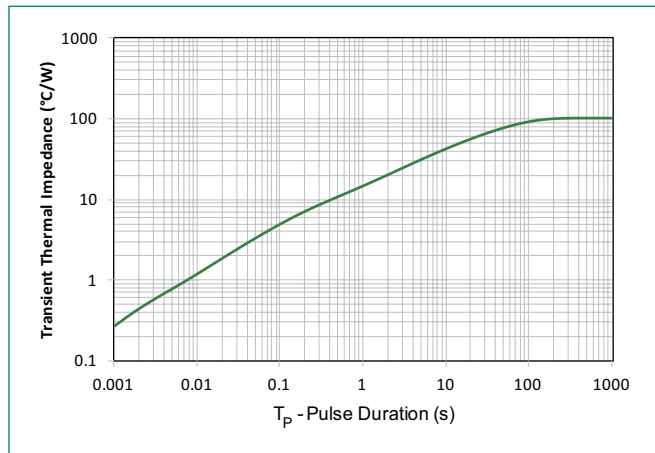

Figure 7 - Maximum Non-Repetitive Peak Forward Surge Current Uni-Directional Only

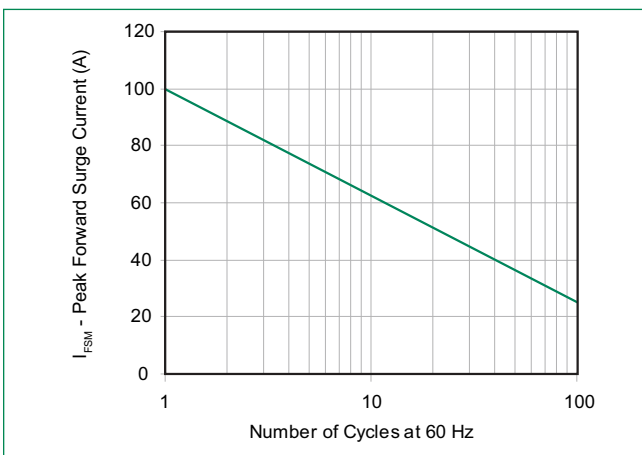
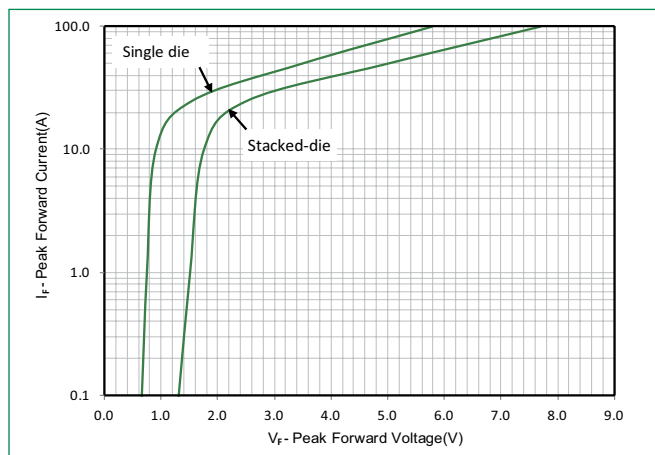
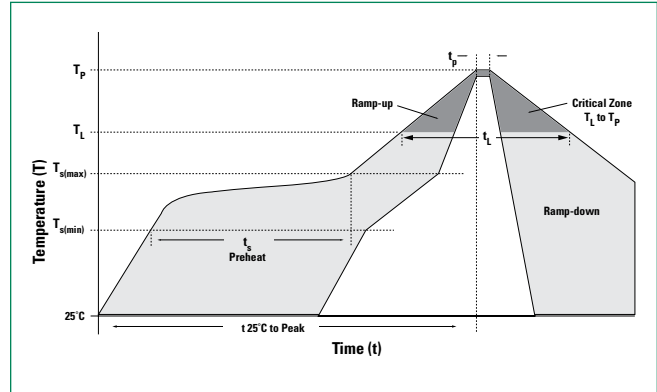

Figure 8 - Peak Forward Voltage Drop vs Peak Forward Current (Typical Values)



Soldering Parameters

| | | |
|--|------------------------------------|-------------------------|
| Reflow Condition | | Pb-Free assembly |
| Pre Heat | - Temperature Min ($T_{s(min)}$) | 150°C |
| | - Temperature Max ($T_{s(max)}$) | 200°C |
| | - Time (min to max) (t_s) | 60 – 120 secs |
| Average ramp up rate (Liquidus Temp (T_L) to peak) | | 3°C/second max |
| $T_{s(max)}$ to T_L - Ramp-up Rate | | 3°C/second max |
| Reflow | - Temperature (T_L) (Liquidus) | 217°C |
| | - Time (min to max) (t_L) | 60 – 150 seconds |
| Peak Temperature (T_p) | | 260 ^{+0/-5} °C |
| Time within 5°C of actual peak Temperature (t_p) | | 30 seconds Max |
| Ramp-down Rate | | 6°C/second Max |
| Time 25°C to peak Temperature (T_p) | | 8 minutes Max. |
| Do not exceed | | 260°C |



Physical Specifications

| | |
|-----------------|---|
| Weight | 0.003 ounce, 0.093 grams |
| Case | JEDEC DO214AA. Molded plastic body over glass passivated junction |
| Polarity | Color band denotes cathode except for bidirectional versions |
| Terminal | Matte Tin-plated leads, Solderable per JESD22-B102 |

Environmental Specifications

| | |
|----------------------------|--------------------------|
| High Temp. Storage | JESD22-A103 |
| HTRB | JESD22-A108 |
| Temperature Cycling | JESD22-A104 |
| MSL | JEDEC-J-STD-020, Level 1 |
| H3TRB | JESD22-A101 |
| RSH | JESD22-A111 |

Dimensions

DO-214AA (SMB J-Bend)

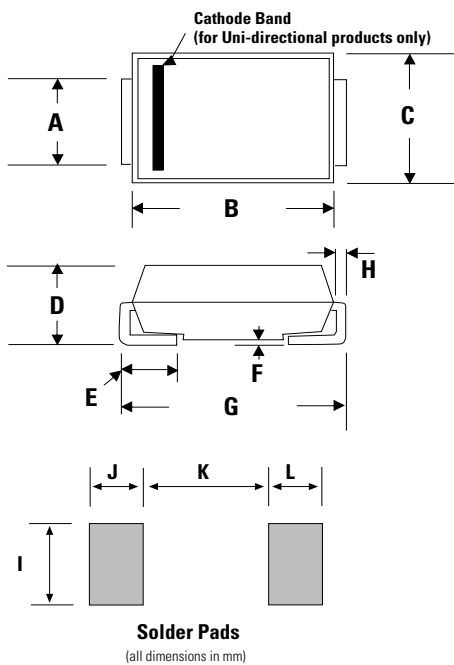

| Dimensions | Inches | | Millimeters | |
|------------|--------|-------|-------------|-------|
| | Min | Max | Min | Max |
| A | 0.076 | 0.086 | 1.930 | 2.200 |
| B | 0.160 | 0.187 | 4.060 | 4.750 |
| C | 0.130 | 0.155 | 3.300 | 3.940 |
| D | 0.078 | 0.103 | 1.990 | 2.610 |
| E | 0.030 | 0.060 | 0.760 | 1.520 |
| F | - | 0.008 | - | 0.203 |
| G | 0.205 | 0.220 | 5.210 | 5.590 |
| H | 0.006 | 0.012 | 0.152 | 0.305 |
| I | 0.089 | - | 2.260 | - |
| J | 0.085 | - | 2.160 | - |
| K | - | 0.107 | - | 2.740 |
| L | 0.085 | - | 2.160 | - |

Part Numbering System

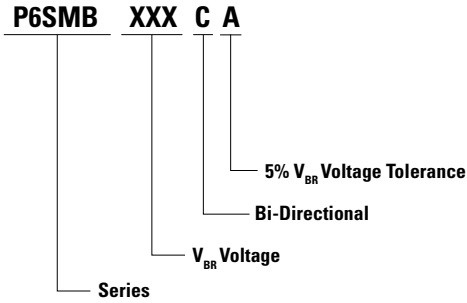

Part Marking System

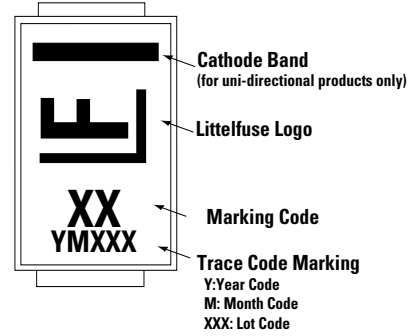

Packaging

| Part number | Component Package | Quantity | Packaging Option | Packaging Specification |
|-------------|-------------------|----------|----------------------------------|-------------------------|
| P6SMBxxxXX | DO-214AA | 3000 | Tape & Reel - 12mm tape/13" reel | EIA STD RS-481 |

Tape and Reel Specification

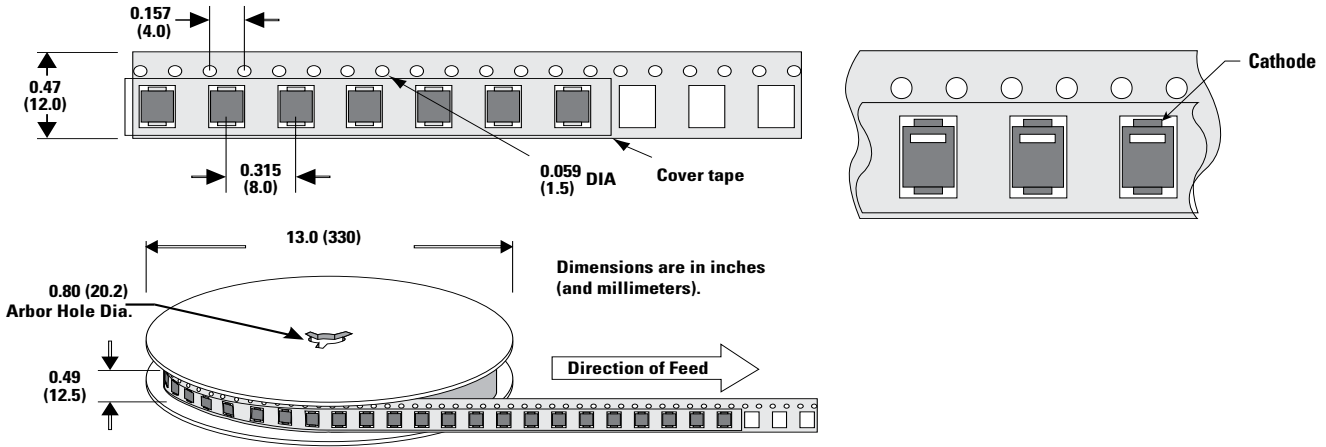

Mouser Electronics

Authorized Distributor

Click to View Pricing, Inventory, Delivery & Lifecycle Information:

Littelfuse:

[P6SMB540](#) [P6SMB300](#) [P6SMB170A](#) [P6SMB400C](#) [P6SMB68A](#) [P6SMB13A](#) [P6SMB350C](#) [P6SMB24CA](#)
[P6SMB10C](#) [P6SMB56C](#) [P6SMB220](#) [P6SMB62C](#) [P6SMB75CA](#) [P6SMB39CA](#) [P6SMB47](#) [P6SMB250C](#) [P6SMB120C](#)
[P6SMB51A](#) [P6SMB91](#) [P6SMB110CA](#) [P6SMB20A](#) [P6SMB220CA](#) [P6SMB6.8C](#) [P6SMB27A](#) [P6SMB15](#) [P6SMB530](#)
[P6SMB18](#) [P6SMB82](#) [P6SMB36A](#) [P6SMB120CA](#) [P6SMB22A](#) [P6SMB480](#) [P6SMB56CA](#) [P6SMB68C](#) [P6SMB30A](#)
[P6SMB10](#) [P6SMB180](#) [P6SMB16](#) [P6SMB510A](#) [P6SMB8.2](#) [P6SMB15CA](#) [P6SMB300CA](#) [P6SMB9.1A](#) [P6SMB110](#)
[P6SMB400CA](#) [P6SMB56](#) [P6SMB18CA](#) [P6SMB150CA](#) [P6SMB180CA](#) [P6SMB8.2CA](#) [P6SMB75](#) [P6SMB27C](#)
[P6SMB12CA](#) [P6SMB30CA](#) [P6SMB39A](#) [P6SMB12](#) [P6SMB550](#) [P6SMB47CA](#) [P6SMB12C](#) [P6SMB180C](#)
[P6SMB530A](#) [P6SMB150](#) [P6SMB36C](#) [P6SMB200A](#) [P6SMB6.8CA](#) [P6SMB100C](#) [P6SMB82A](#) [P6SMB8.2C](#)
[P6SMB43A](#) [P6SMB22CA](#) [P6SMB100A](#) [P6SMB480A](#) [P6SMB100CA](#) [P6SMB540CA](#) [P6SMB160A](#) [P6SMB160CA](#)
[P6SMB200CA](#) [P6SMB7.5](#) [P6SMB170C](#) [P6SMB160C](#) [P6SMB350CA](#) [P6SMB43CA](#) [P6SMB24A](#) [P6SMB13](#)
[P6SMB200C](#) [P6SMB13C](#) [P6SMB6.8](#) [P6SMB7.5C](#) [P6SMB68CA](#) [P6SMB47A](#) [P6SMB43C](#) [P6SMB33A](#) [P6SMB110C](#)
[P6SMB550C](#) [P6SMB9.1C](#) [P6SMB110A](#) [P6SMB250CA](#) [P6SMB18A](#) [P6SMB540A](#) [P6SMB51C](#)