

# MBRM130LT1G, NRVBM130LT1G, MBRM130LT3G, NRVBM130LT3G



**ON Semiconductor®**

<http://onsemi.com>

## Surface Mount Schottky Power Rectifier

### POWERMITE® Power Surface Mount Package

The SchottkyPOWERMITE® employs the Schottky Barrier principle with a barrier metal and epitaxial construction that produces optimal forward voltage drop–reverse current tradeoff. The advanced packaging techniques provide for a highly efficient micro miniature, space saving surface mount Rectifier. With its unique heatsink design, thePOWERMITE® has the same thermal performance as the SMA while being 50% smaller in footprint area, and delivering one of the lowest height profiles, < 1.1 mm in the industry. Because of its small size, it is ideal for use in portable and battery powered products such as cellular and cordless phones, chargers, notebook computers, printers, PDAs and PCMCIA cards. Typical applications are AC–DC and DC–DC converters, reverse battery protection, and “ORing” of multiple supply voltages and any other application where performance and size are critical.

#### Features

- Low Profile – Maximum Height of 1.1 mm
- Small Footprint – Footprint Area of 8.45 mm<sup>2</sup>
- Low V<sub>F</sub> Provides Higher Efficiency and Extends Battery Life
- Supplied in 12 mm Tape and Reel
- Low Thermal Resistance with Direct Thermal Path of Die on Exposed Cathode Heat Sink
- ESD Ratings:
  - ◆ Human Body Model = 3B (> 16 kV)
  - ◆ Machine Model = C (> 400 V)
- AEC–Q101 Qualified and PPAP Capable
- NRVB Prefix for Automotive and Other Applications Requiring Unique Site and Control Change Requirements
- All Packages are Pb–Free\*

#### Mechanical Characteristics:

- POWERMITE® is JEDEC Registered as D0–216AA
- Case: Molded Epoxy
- Epoxy Meets UL 94 V–0 @ 0.125 in
- Weight: 16.3 mg (Approximately)
- Lead and Mounting Surface Temperature for Soldering Purposes: 260°C Maximum for 10 Seconds

\*For additional information on our Pb–Free strategy and soldering details, please download the ON Semiconductor Soldering and Mounting Techniques Reference Manual, SOLDERRM/D.

### SCHOTTKY BARRIER RECTIFIER 1.0 AMPERES, 30 VOLTS

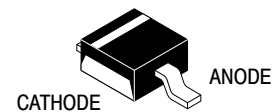

**POWERMITE  
CASE 457  
PLASTIC**

#### MARKING DIAGRAM

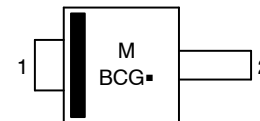

M = Date Code  
BCG = Device Code  
■ = Pb–Free Package

#### ORDERING INFORMATION

Device	Package	Shipping†
MBRM130LT1G	POWERMITE (Pb–Free)	3,000 / Tape & Reel
NRVBM130LT1G	POWERMITE (Pb–Free)	3,000 / Tape & Reel
MBRM130LT3G	POWERMITE (Pb–Free)	12,000 / Tape & Reel
NRVBM130LT3G	POWERMITE (Pb–Free)	12,000 / Tape & Reel

†For information on tape and reel specifications, including part orientation and tape sizes, please refer to our Tape and Reel Packaging Specifications Brochure, BRD8011/D.

# MBRM130LT1G, NRVBM130LT1G, MBRM130LT3G, NRVBM130LT3G

## MAXIMUM RATINGS

Rating	Symbol	Value	Unit
Peak Repetitive Reverse Voltage Working Peak Reverse Voltage DC Blocking Voltage	$V_{RRM}$ $V_{RWM}$ $V_R$	30	V
Average Rectified Forward Current (At Rated $V_R$ , $T_C = 135^\circ\text{C}$ )	$I_O$	1.0	A
Peak Repetitive Forward Current (At Rated $V_R$ , Square Wave, 100 kHz, $T_C = 135^\circ\text{C}$ )	$I_{FRM}$	2.0	A
Non-Repetitive Peak Surge Current (Non-Repetitive peak surge current, halfwave, single phase, 60 Hz)	$I_{FSM}$	50	A
Storage Temperature	$T_{stg}$	-55 to 150	$^\circ\text{C}$
Operating Junction Temperature	$T_J$	-55 to 125	$^\circ\text{C}$
Voltage Rate of Change (Rated $V_R$ , $T_J = 25^\circ\text{C}$ )	dv/dt	10,000	V/ $\mu\text{s}$

Stresses exceeding Maximum Ratings may damage the device. Maximum Ratings are stress ratings only. Functional operation above the Recommended Operating Conditions is not implied. Extended exposure to stresses above the Recommended Operating Conditions may affect device reliability.

## THERMAL CHARACTERISTICS

Characteristic	Symbol	Value	Unit
Thermal Resistance, Junction-to-Lead (Anode) (Note 1)	$R_{tjl}$	35	$^\circ\text{C}/\text{W}$
Thermal Resistance, Junction-to-Tab (Cathode) (Note 1)	$R_{tjtab}$	23	
Thermal Resistance, Junction-to-Ambient (Note 1)	$R_{tja}$	277	

1. Mounted with minimum recommended pad size, PC Board FR4, See Figures 9 & 10

## ELECTRICAL CHARACTERISTICS

Characteristic	Symbol	Value		Unit
		$T_J = 25^\circ\text{C}$	$T_J = 85^\circ\text{C}$	
Maximum Instantaneous Forward Voltage (Note 2), See Figure 2  ( $I_F = 0.1\text{ A}$ ) ( $I_F = 1.0\text{ A}$ ) ( $I_F = 3.0\text{ A}$ )	$V_F$	0.30 0.38 0.52	0.20 0.33 0.50	V
Maximum Instantaneous Reverse Current (Note 2), See Figure 4  ( $V_R = 30\text{ V}$ ) ( $V_R = 20\text{ V}$ ) ( $V_R = 10\text{ V}$ )	$I_R$	0.41 0.13 0.05	11 5.3 3.2	mA

2. Pulse Test: Pulse Width  $\leq 250\ \mu\text{s}$ , Duty Cycle  $\leq 2\%$

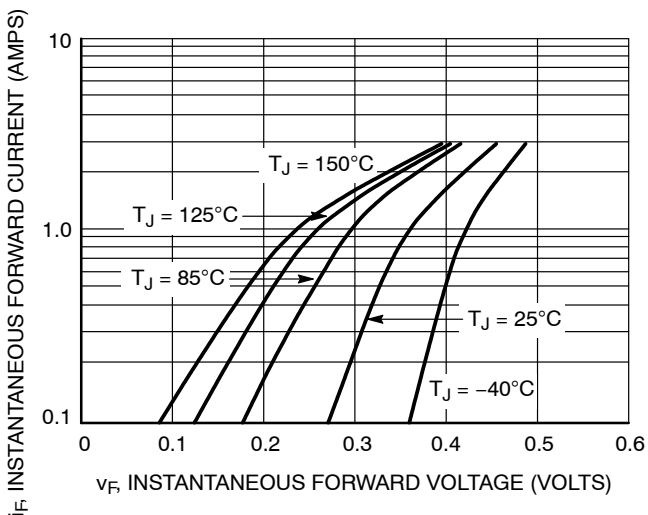

Figure 1. Typical Forward Voltage

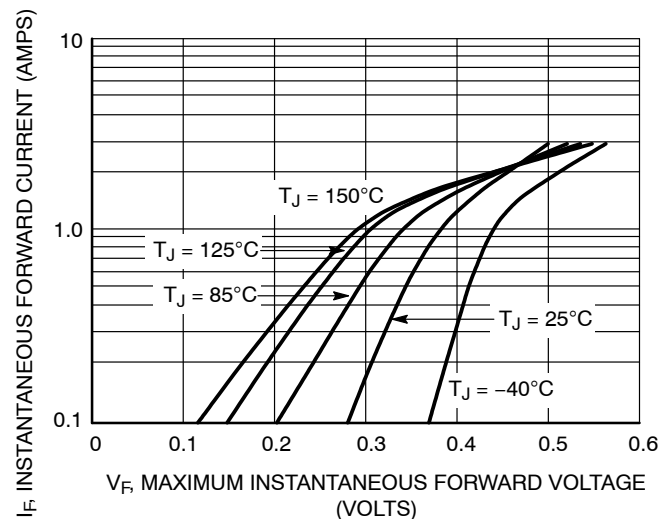

Figure 2. Maximum Forward Voltage

# MBRM130LT1G, NRVBM130LT1G, MBRM130LT3G, NRVBM130LT3G

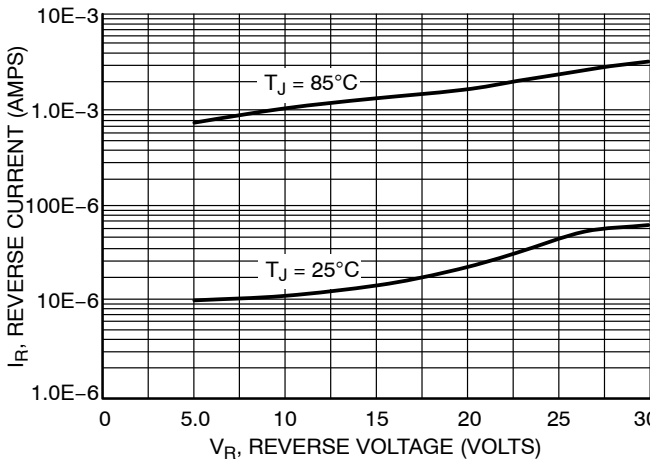

Figure 3. Typical Reverse Current

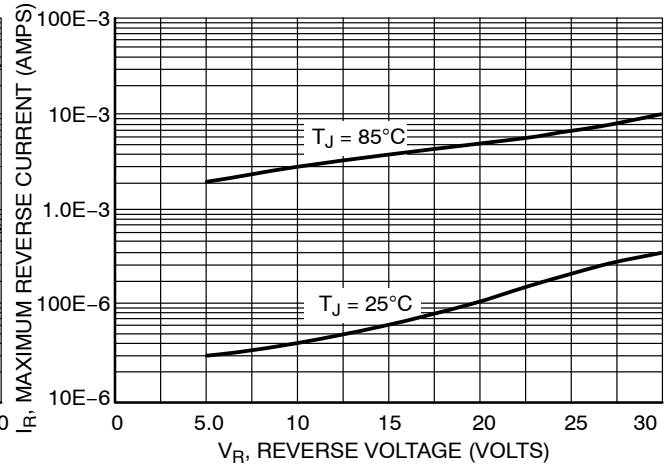

Figure 4. Maximum Reverse Current

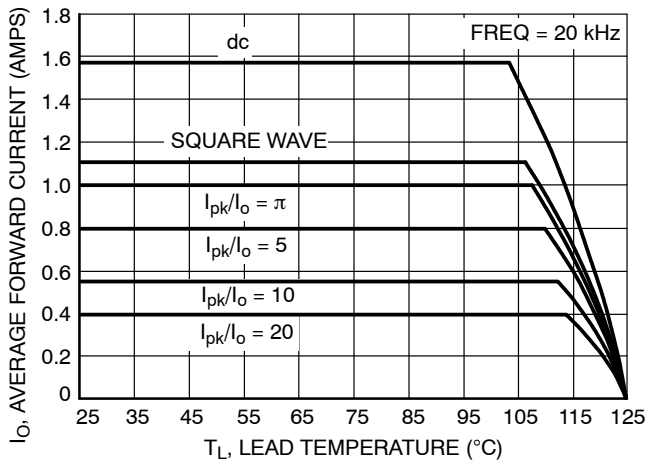

Figure 5. Current Derating

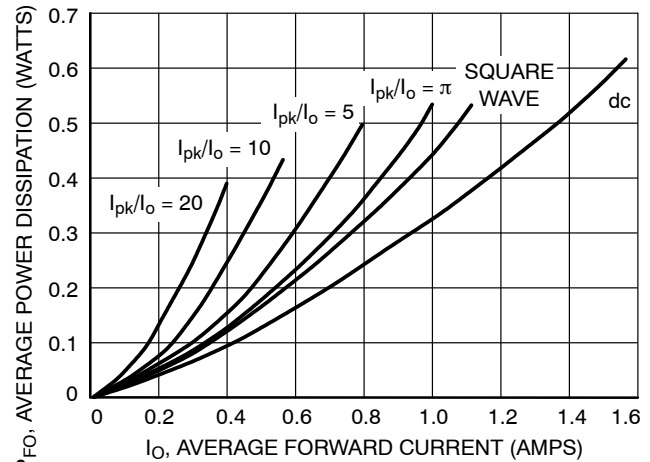

Figure 6. Forward Power Dissipation

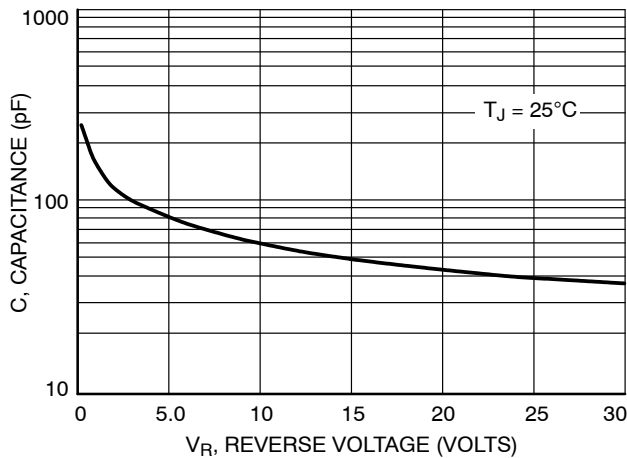

Figure 7. Capacitance

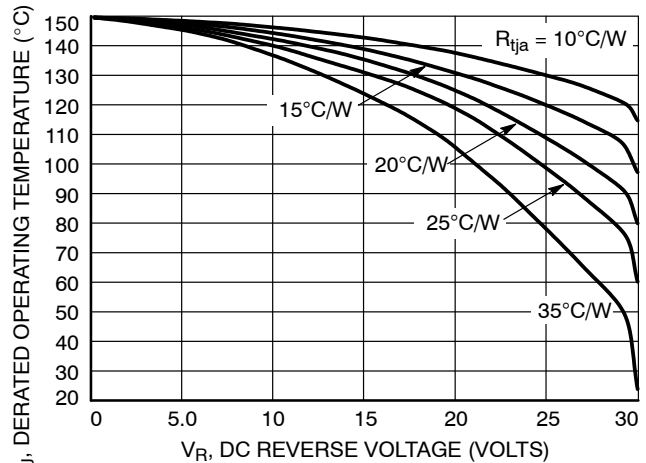

Figure 8. Typical Operating Temperature Derating\*

\* Reverse power dissipation and the possibility of thermal runaway must be considered when operating this device under any reverse voltage conditions. Calculations of  $T_J$  therefore must include forward and reverse power effects. The allowable operating  $T_J$  may be calculated from the equation:

$$T_J = T_{Jmax} - r(t)(P_f + P_r) \text{ where}$$

$r(t)$  = thermal impedance under given conditions,  
 $P_f$  = forward power dissipation, and  
 $P_r$  = reverse power dissipation

This graph displays the derated allowable  $T_J$  due to reverse bias under DC conditions only and is calculated as  $T_J = T_{Jmax} - r(t)P_r$ , where  $r(t) = R_{thja}$ . For other power applications further calculations must be performed.

**MBRM130LT1G, NRVBM130LT1G, MBRM130LT3G, NRVBM130LT3G**

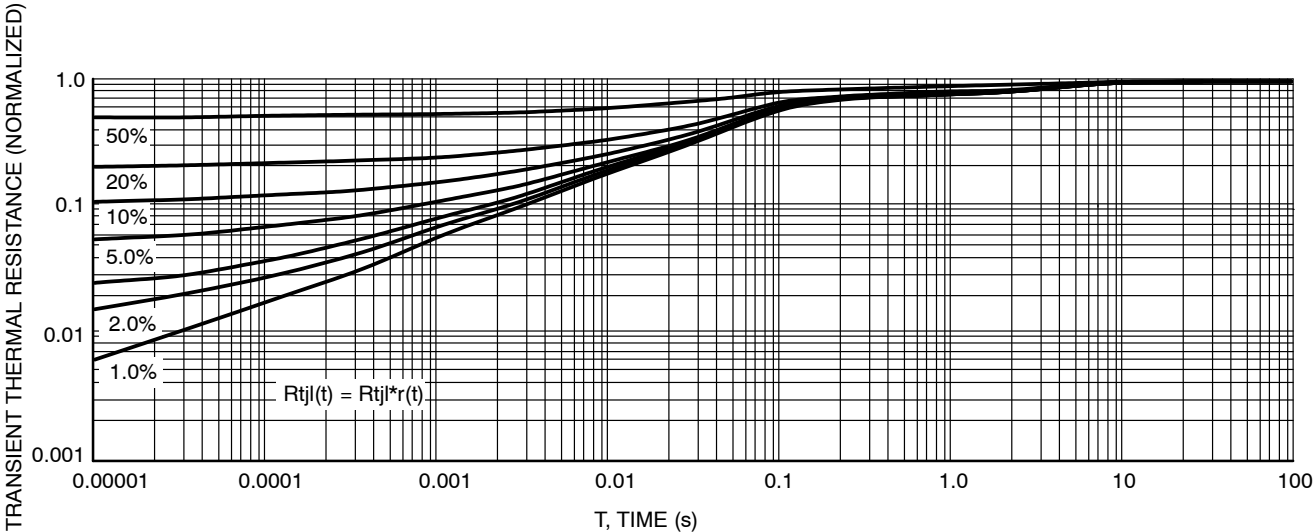

**Figure 9. Thermal Response Junction to Lead**

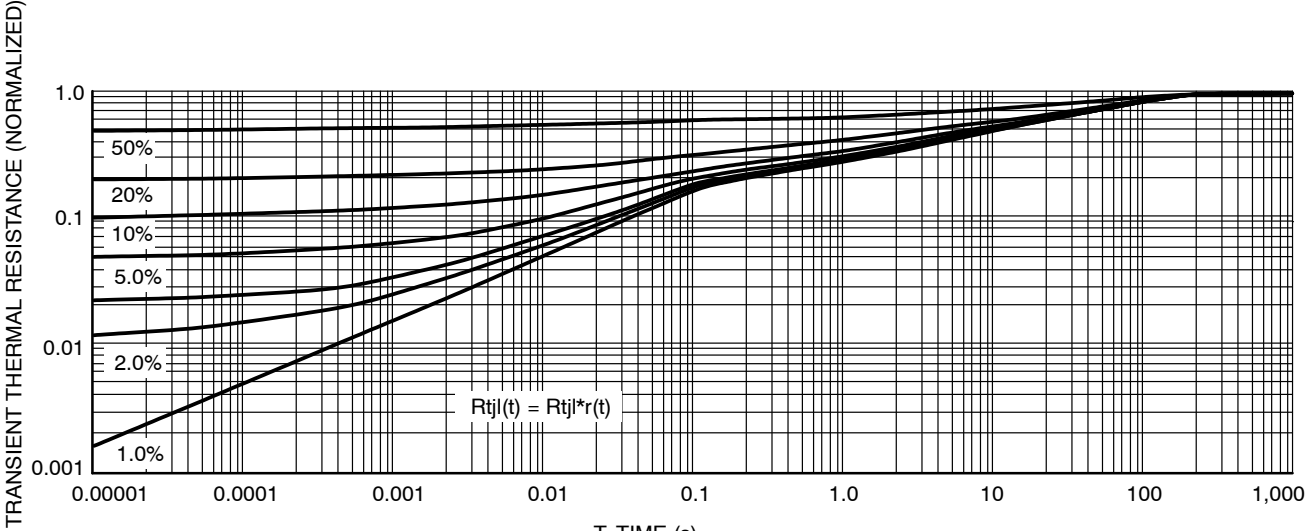
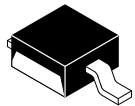

**Figure 10. Thermal Response Junction to Ambient**

POWERMITE is a registered trademark of and used under a license from Microsemi Corporation.

# MECHANICAL CASE OUTLINE PACKAGE DIMENSIONS

ON Semiconductor®



SCALE 4:1

## POWERMITE CASE 457-04 ISSUE F

DATE 14 MAY 2013

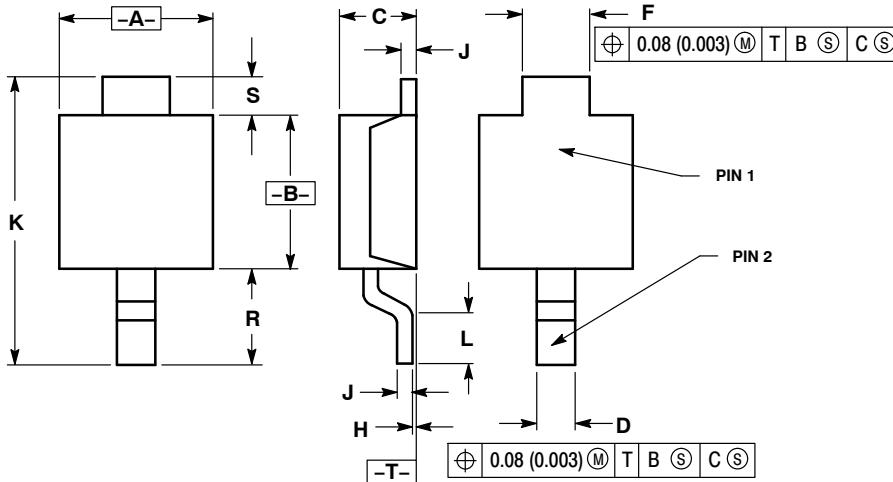

NOTES:

1. DIMENSIONING AND TOLERANCING PER ANSI Y14.5M, 1982.
2. CONTROLLING DIMENSION: MILLIMETER.
3. DIMENSIONS A AND B DO NOT INCLUDE MOLD FLASH, PROTRUSIONS OR GATE BURRS. MOLD FLASH, PROTRUSIONS OR GATE BURRS SHALL NOT EXCEED 0.15 (0.006) PER SIDE.

DIM	MILLIMETERS		INCHES	
	MIN	MAX	MIN	MAX
A	1.75	2.05	0.069	0.081
B	1.75	2.18	0.069	0.086
C	0.85	1.15	0.033	0.045
D	0.40	0.69	0.016	0.027
F	0.70	1.00	0.028	0.039
H	-0.05	+0.10	-0.002	+0.004
J	0.10	0.25	0.004	0.010
K	3.60	3.90	0.142	0.154
L	0.50	0.80	0.020	0.031
R	1.20	1.50	0.047	0.059
S	0.50	REF	0.019	REF

- STYLE 1:  
PIN 1. CATHODE  
2. ANODE
- STYLE 2:  
PIN 1. ANODE OR CATHODE  
2. CATHODE OR ANODE  
(BI-DIRECTIONAL)
- STYLE 3:  
PIN 1. ANODE  
2. CATHODE

### SOLDERING FOOTPRINT\*

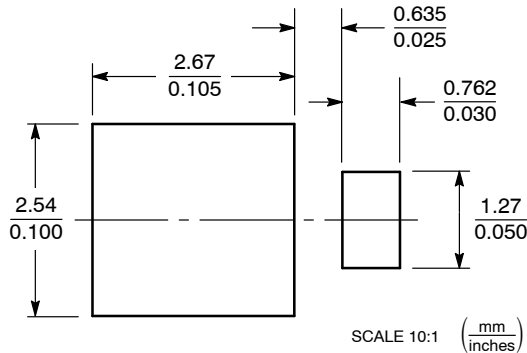

### GENERIC MARKING DIAGRAMS\*

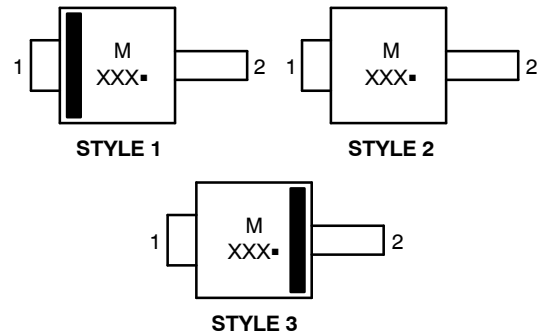

XXX = Specific Device Code  
M = Date Code  
▪ = Pb-Free Package

\*This information is generic. Please refer to device data sheet for actual part marking. Pb-Free indicator, "G" or microdot "▪", may or may not be present.

\*For additional information on our Pb-Free strategy and soldering details, please download the ON Semiconductor Soldering and Mounting Techniques Reference Manual, SOLDERRM/D.

DOCUMENT NUMBER:	98ASB14853C	Electronic versions are uncontrolled except when accessed directly from the Document Repository. Printed versions are uncontrolled except when stamped "CONTROLLED COPY" in red.
DESCRIPTION:	POWERMITE	PAGE 1 OF 1

ON Semiconductor and ON are trademarks of Semiconductor Components Industries, LLC dba ON Semiconductor or its subsidiaries in the United States and/or other countries. ON Semiconductor reserves the right to make changes without further notice to any products herein. ON Semiconductor makes no warranty, representation or guarantee regarding the suitability of its products for any particular purpose, nor does ON Semiconductor assume any liability arising out of the application or use of any product or circuit, and specifically disclaims any and all liability, including without limitation special, consequential or incidental damages. ON Semiconductor does not convey any license under its patent rights nor the rights of others.

**onsemi**, **Onsemi**, and other names, marks, and brands are registered and/or common law trademarks of Semiconductor Components Industries, LLC dba "**onsemi**" or its affiliates and/or subsidiaries in the United States and/or other countries. **onsemi** owns the rights to a number of patents, trademarks, copyrights, trade secrets, and other intellectual property. A listing of **onsemi**'s product/patent coverage may be accessed at [www.onsemi.com/site/pdf/Patent-Marking.pdf](http://www.onsemi.com/site/pdf/Patent-Marking.pdf). **onsemi** reserves the right to make changes at any time to any products or information herein, without notice. The information herein is provided "as-is" and **onsemi** makes no warranty, representation or guarantee regarding the accuracy of the information, product features, availability, functionality, or suitability of its products for any particular purpose, nor does **onsemi** assume any liability arising out of the application or use of any product or circuit, and specifically disclaims any and all liability, including without limitation special, consequential or incidental damages. Buyer is responsible for its products and applications using **onsemi** products, including compliance with all laws, regulations and safety requirements or standards, regardless of any support or applications information provided by **onsemi**. "Typical" parameters which may be provided in **onsemi** data sheets and/or specifications can and do vary in different applications and actual performance may vary over time. All operating parameters, including "Typicals" must be validated for each customer application by customer's technical experts. **onsemi** does not convey any license under any of its intellectual property rights nor the rights of others. **onsemi** products are not designed, intended, or authorized for use as a critical component in life support systems or any FDA Class 3 medical devices or medical devices with a same or similar classification in a foreign jurisdiction or any devices intended for implantation in the human body. Should Buyer purchase or use **onsemi** products for any such unintended or unauthorized application, Buyer shall indemnify and hold **onsemi** and its officers, employees, subsidiaries, affiliates, and distributors harmless against all claims, costs, damages, and expenses, and reasonable attorney fees arising out of, directly or indirectly, any claim of personal injury or death associated with such unintended or unauthorized use, even if such claim alleges that **onsemi** was negligent regarding the design or manufacture of the part. **onsemi** is an Equal Opportunity/Affirmative Action Employer. This literature is subject to all applicable copyright laws and is not for resale in any manner.

## PUBLICATION ORDERING INFORMATION

### LITERATURE FULFILLMENT:

Email Requests to: [orderlit@onsemi.com](mailto:orderlit@onsemi.com)

**onsemi Website:** [www.onsemi.com](http://www.onsemi.com)

### TECHNICAL SUPPORT

**North American Technical Support:**

Voice Mail: 1 800-282-9855 Toll Free USA/Canada

Phone: 011 421 33 790 2910

**Europe, Middle East and Africa Technical Support:**

Phone: 00421 33 790 2910

For additional information, please contact your local Sales Representative