

SCDS Series

SMD Power Inductors

APPLICATIONS

Power Supply for VTRs, OA Equipment, LCD Televisions, Notebook PCs, Portable Communication Equipment

DC-DC Converters, etc.

FEATURES

Available in magnetically shielded

Low DC resistance

Suitable for large currents

Ideal for a variety of DC-DC converter inductor applications.

Available on tape and reel for auto surface mounting.

SHAPES AND DIMENSIONS

Unit: mm

SCDS62/64

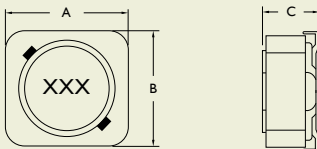

SCDS73/74

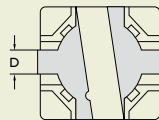
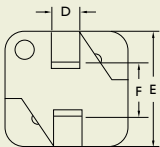
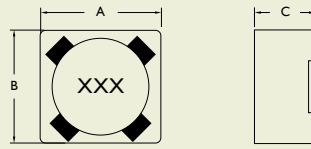

TYPE	A	B	C	D	E	F
SCDS62	6.2 ± 0.3	5.9 ± 0.3	3 ⁺⁰	1.5	6.0 ± 0.3	2.8
SCDS64	6.2 ± 0.3	5.9 ± 0.3	5 ⁺⁰	1.5	6.0 ± 0.3	2.8
SCDS73	7.3 ± 0.2	7.3 ± 0.2	3.4 ⁺⁰	1.8		
SCDS74	7.3 ± 0.2	7.3 ± 0.2	4.5 ⁺⁰	1.8		
SCDS124	12.5 ⁺⁰	12.5 ⁺⁰	4.5 ⁺⁰	5	7.6	
SCDS125	12.5 ⁺⁰	12.5 ⁺⁰	6 ⁺⁰	5	7.6	
SCDS127	12.5 ⁺⁰	12.5 ⁺⁰	8 ⁺⁰	5	7.6	



PRODUCT IDENTIFICATION

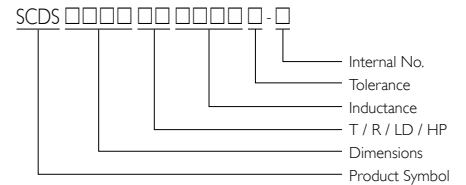

- T = Tape and Reel, R = Core Style (Round), LD = Low DCR, HP = High Power
- Internal No.: S = Base Type Terminals, N = Lead-Free

SCDS124/125/127

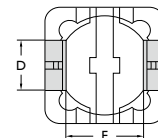
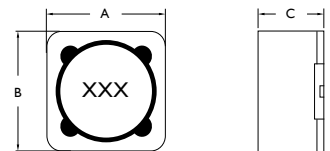



ELECTRICAL CHARACTERISTICS

STAMP	INDUCTANCE (μ H)	DC RESISTANCE (Ω) Max.							RATED CURRENT (A)						
		SCDS 62T	SCDS 64T	SCDS 73	SCDS 74	SCDS 124	SCDS 125	SCDS 127	SCDS 62T	SCDS 64T	SCDS 73	SCDS 74	SCDS 124	SCDS 125	SCDS 127
1R2	1.2							7.0							9.80
2R4	2.4							11.5							8.00
3R3	3.3	68							1.94						
3R5	3.5							13.5							7.50
3R9	3.9					15							6.50		
4R7	4.7	80				18		15.8	1.63				5.70	6.80	
5R5	5.5	96							1.40						
6R1	6.1							17.6							6.60
6R8	6.8	100				23			1.33				4.90		
7R6	7.6							20.0							5.90
8R2	8.2	100							1.14						
120	12	200	130	98	58	38	27	24.3	1.00	1.22	1.52	1.71	4.00	3.50	4.90
150	15	230	180	130	81	50	30	27.0	0.90	1.11	1.33	1.47	3.20	3.30	4.50
180	18	270	240	140	91	57	34	39.2	0.80	1.02	1.20	1.31	3.10	3.00	3.90
220	22	340	270	190	110	66	36	43.2	0.74	0.91	1.07	1.23	2.90	2.80	3.60
270	27	380	300	210	150	80	51	45.9	0.66	0.82	0.96	1.12	2.80	2.30	3.40
330	33	450	330	240	170	97	57	64.8	0.59	0.74	0.91	0.96	2.70	2.10	3.00
390	39	490	370	320	230	132	68	72.9	0.54	0.69	0.77	0.91	2.10	2.00	2.75
470	47	690	520	360	260	150	75	100	0.50	0.62	0.76	0.88	1.90	1.80	2.50
560	56	780	560	470	350	190	110	110	0.46	0.58	0.68	0.75	1.80	1.70	2.35
680	68	1,070	630	520	380	220	120	140	0.42	0.51	0.61	0.69	1.50	1.50	2.10
820	82	1,210	710	690	430	260	140	160	0.38	0.46	0.57	0.61	1.30	1.40	1.95
101	100	1,390	1,030	790	610	308	160	220	0.34	0.42	0.50	0.60	1.20	1.30	1.70
121	120	1,900	1,150	890	660	380	170	250	0.31	0.38	0.49	0.52	1.10	1.10	1.60
151	150	2,180	1,680	1,270	880	530	230	280	0.28	0.35	0.43	0.46	0.95	1.00	1.42
181	180	2,770	1,870	1,450	980	620	290	350	0.26	0.32	0.39	0.42	0.85	0.90	1.30
221	220	3,120	2,080	1,650	1,170	700	400	390	0.23	0.29	0.35	0.36	0.80	0.80	1.16
271	270	4,380	2,370	2,310	1,640	876	460	560	0.22	0.26	0.32	0.34	0.60	0.75	1.06
331	330	4,940	2,670	2,620	1,860	990	510	640	0.19	0.23	0.28	0.32	0.50	0.68	0.95
391	390		2,940	2,940	2,850		690	700		0.22	0.26	0.29		0.65	0.88

ELECTRICAL CHARACTERISTICS

STAMP	INDUCTANCE (μH)	DC RESISTANCE (Ω) Max.							RATED CURRENT (A)						
		SCDS 62T	SCDS 64T	SCDS 73	SCDS 74	SCDS 124	SCDS 125	SCDS 127	SCDS 62T	SCDS 64T	SCDS 73	SCDS 74	SCDS 124	SCDS 125	SCDS 127
471	470		3,930	4,180	3,010		770	980		0.20	0.24	0.26		0.58	0.79
561	560		5,430	4,670	3,620		860	1,070		0.18	0.22	0.23		0.54	0.73
681	680		7,320	5,730	4,630		1,200	1,460		0.17	0.19	0.22		0.48	0.67
821	820		8,240	6,540	5,200		1,340	1,640		0.15	0.18	0.20		0.43	0.60
102	1,000		9,260	9,440	6,000		1,530	1,820		0.14	0.16	0.18		0.40	0.55

Note:

Test Freq.(L): SCDS62T: 3.3 to 8.2 μH (7.96MHz/1V), 10 to 82 μH (2.52MHz/1V), 100 to 330 μH (1KHz/1V)

SCDS64T/73/74/125: (1KHz/1V); SCDS124: (100KHz/1V); SCDS127: 1.2 to 7.6 μH (100KHz/1V), 10 to 1,000 μH (1KHz/1V)

Test Instrument: L- HP 4192A LF Impedance analyzer; RDC- CH502BC, Rated Current- HP4284+42841A or CH1061+CH301A

Rated current: The rated current indicates the current when the inductance decrease to 65%. Over of it's nominal value or D.C. current when the temperature rising $\Delta T = 40\text{ }^\circ\text{C}$ lower, whichever is lower.

Tolerance: M = $\pm 20\%$, T = $\pm 30\%$, N = +40% / -20%

TOLERANCE OF INDUCTORS

SCDS62T	3.3 to 330 $\mu\text{H} \pm 20\%$	SCDS124	3.9 to 330 $\mu\text{H} \pm 20\%$
SCDS64T	10 to 1,000 $\mu\text{H} \pm 20\%$	SCDS125	10 to 1,000 $\mu\text{H} \pm 20\%$
SCDS73	10 to 1,000 $\mu\text{H} \pm 20\%$	SCDS127	1.2 to 7.6 $\mu\text{H} +40\% / -20\%$
SCDS74	10 to 1,000 $\mu\text{H} \pm 20\%$		10 to 1,000 $\mu\text{H} \pm 20\%$



TAPE DIMENSIONS

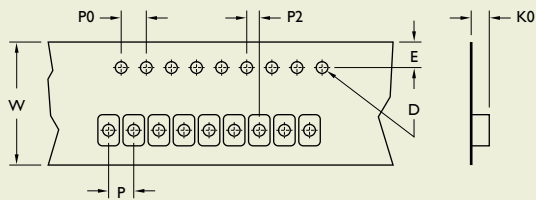

TAPE MATERIAL

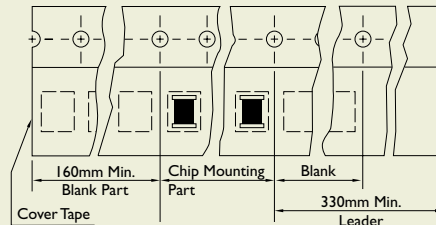

REEL DIMENSIONS

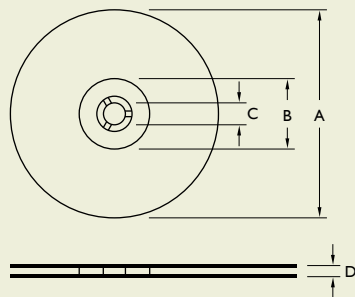

RECOMMENDED PATTERN

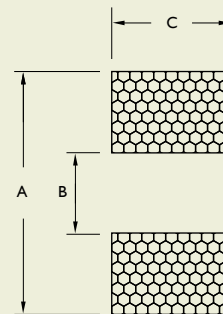

Dimensions: mm

TYPE	TAPE DIMENSIONS							RECOMMENDED PATTERN			REEL DIMENSIONS				QUANTITY/ REEL
	K0	D	E	W	P	P0	P2	A	B	C	A	B	C	D	
SCDS62	3.40	1.55	1.75	16	12	4	2	8.1	4.0	2.5	330	100	13	17.4	1,500
SCDS64	4.90	1.55	1.75	16	12	4	2	8.1	4.0	2.5	330	100	13	17.4	1,000
SCDS73	3.60	1.55	1.75	16	12	4	2	8.4	4.4	2.2	330	100	13	17.4	1,600
SCDS74	5.00	1.55	1.75	16	12	4	2	8.4	4.4	2.2	330	100	13	17.4	1,000
SCDS124	5.10	1.55	1.75	24	16	4	2	13.0	7.0	5.4	330	100	13	24.4	500
SCDS125	6.70	1.55	1.75	24	16	4	2	13.0	7.0	5.4	330	100	13	24.4	600
SCDS127	8.70	1.55	1.75	24	16	4	2	13.0	7.0	5.4	330	100	13	24.4	500

SCDS Series

SMD Power Inductors

APPLICATIONS

- Power Supply for VTRs
- OA Equipment
- LCD Televisions
- Notebook PCs
- Portable Communication Equipment
- DC-DC Converters, etc.

FEATURES

- Available in magnetically shielded
- Low DC resistance
- Suitable for large currents
- Ideal for a variety of DC-DC converter inductor applications.
- Available on tape and reel for auto surface mounting.

SHAPES AND DIMENSIONS

TYPE	A	B	C	D	E	F	G
SCDS104R	10.3 ⁺⁰	10.5 ⁺⁰	4 ⁺⁰	1.2	3.0	7.7	13.5 ⁺⁰
SCDS105R	10.3 ⁺⁰	10.5 ⁺⁰	5.1 ⁺⁰	1.2	3.0	7.7	13.5 ⁺⁰



PRODUCT IDENTIFICATION

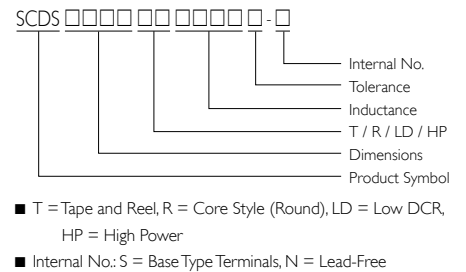

Unit: mm

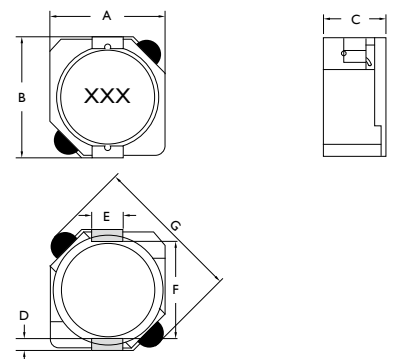



ELECTRICAL CHARACTERISTICS

STAMP	INDUCTANCE (μH)	DC RESISTANCE (Ω) Max.		RATED CURRENT (A)	
		SCDS104R	SCDS105R	SCDS104R	SCDS105R
R80	0.8		4.3		13.50
1R5	1.5	8.1	5.8	10.00	10.50
2R2	2.2		7.2		9.25
2R5	2.5	10.5		7.50	
3R3	3.3		10.4		7.80
3R8	3.8	13		6.00	
4R7	4.7		12.3		6.40
5R2	5.2	22		5.50	
6R8	6.8		18		5.40
7R0	7.0	27		4.80	
8R2	8.2		20		4.85
100	10	35	26	4.40	4.45
120	12		33		4.00
150	15	50	41	3.60	3.60
180	18		46		3.20
220	22	73	61	2.90	2.95
270	27		69		2.70
330	33	93	84	2.30	2.50
390	39		106		2.30
470	47	128	130	2.10	2.00
560	56		149		1.90
680	68	213	201	1.50	1.65
820	82		227		1.50
101	100	304	253	1.35	1.35
121	120		303		1.28
151	150	506	370	1.15	1.12
181	180		419		1.04
221	220	756	500	0.92	0.94
271	270		672		0.84
331	330	1,09	812	0.70	0.75
391	390		953		0.70
471	470		1,289		0.60
561	560		1,430		0.54
681	680		1,599		0.52
821	820		1,768		0.50
102	1,000		1,989		0.48

Note:

Test Freq.(L): 100KHz/1V

Test Instrument: L- HP 4192A LF Impedance analyzer; RDC- CH502BC, Rated Current- HP4284+42841A or CH1061+CH301A

Rated current: The rated current indicates the current when the inductance decrease to 65%. Over of it's nominal value or D.C. current when the temperature rising

$\Delta T = 40^\circ\text{C}$ lower; whichever is lower.

Tolerance: M = $\pm 20\%$, T = $\pm 30\%$, N = $+40\%$ / -20%

Tolerance of Inductors: SCDS104R: 1.5 to 330 $\mu\text{H} \pm 30\%$; SCDS105R: 0.8 to 1,000 $\mu\text{H} \pm 30\%$

TAPE DIMENSIONS

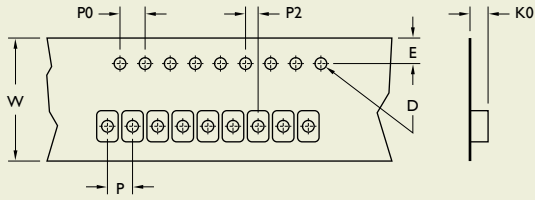

TAPE MATERIAL

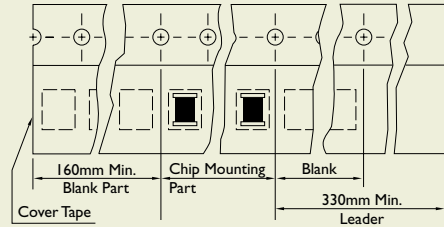

REEL DIMENSIONS

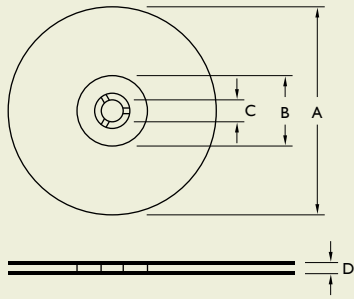

RECOMMENDED PATTERN

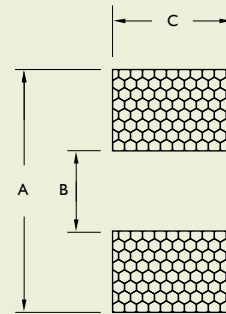

Dimensions: mm

TYPE	TAPE DIMENSIONS							RECOMMENDED PATTERN			REEL DIMENSIONS				QUANTITY/ REEL
	K0	D	E	W	P	P0	P2	A	B	C	A	B	C	D	
SCDS104R	4.10	1.50	1.75	24	16	4	2	1.6	7.3	3.2	330	100	13	24.4	1,000
SCDS105R	5.00	1.50	1.75	24	16	4	2	1.6	7.3	3.2	330	100	13	24.4	500

SMD Power Inductors

SCDS Series



PRODUCT IDENTIFICATION

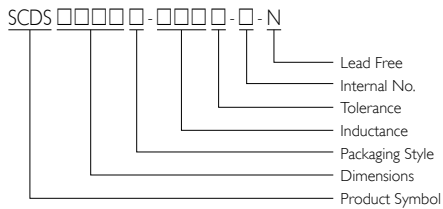
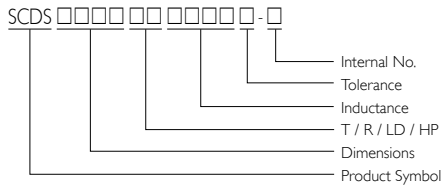

- T = Tape and Reel, R = Core Style (Round), LD = Low DCR, HP = High Power
- Internal No.: S = Base Type Terminals, N = Lead-Free

APPLICATIONS

Power Supply for VTRs

OA Equipment

LCD Televisions

Notebook PCs

Portable Communication Equipment

DC-DC Converters, etc.

FEATURES

Available in magnetically shielded

Low DC resistance

Suitable for large currents

Ideal for a variety of DC-DC converter inductor applications.

Available on tape and reel for auto surface mounting.

SHAPES AND DIMENSIONS

Unit: mm

Figure 1

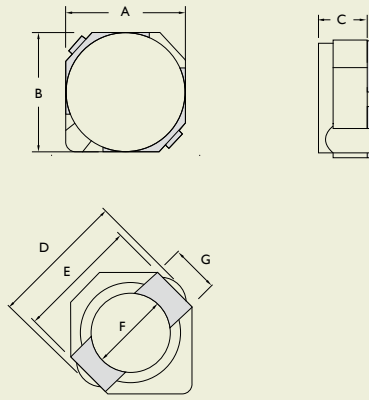

Figure 2

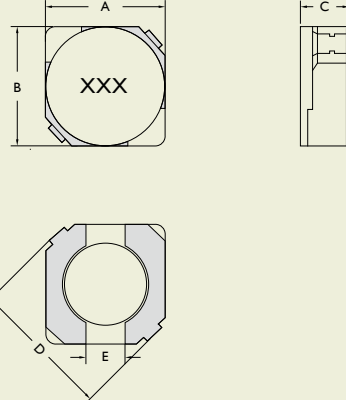
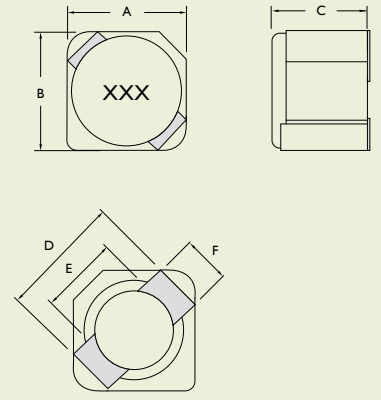

Figure 3



TYPE	FIGURE	A	B	C	D	E	F	G
SCDS2D09	1	3.2 ⁺⁰	3.2 ⁺⁰	1.0 ⁺⁰	4.5 ⁺⁰	3.3	2.1	1.0
SCDS2D11	1	3.2 ⁺⁰	3.2 ⁺⁰	1.2 ⁺⁰	4.5 ⁺⁰	3.3	2.1	1.0
SCDS2D14	1	3.2 ⁺⁰	3.2 ⁺⁰	1.55 ⁺⁰	4.5 ⁺⁰	3.3	2.1	1.0
SCDS2D18LD	1	3.2 ⁺⁰	3.2 ⁺⁰	2.0 ⁺⁰	4.5 ⁺⁰	3.3	2.1	1.0
SCDS2D18HP	1	3.2 ⁺⁰	3.2 ⁺⁰	2.0 ⁺⁰	4.5 ⁺⁰	3.3	2.1	1.0
SCDS3D11	1	4.0 ⁺⁰	4.0 ⁺⁰	1.2 ⁺⁰	5.2 ⁺⁰	4.4	2.8	1.1
SCDS3D11HP	1	4.0 ⁺⁰	4.0 ⁺⁰	1.2 ⁺⁰	5.2 ⁺⁰	4.4	2.8	1.1
SCDS3D16	2	4.0 ⁺⁰	4.0 ⁺⁰	1.8 ⁺⁰	5.2 ⁺⁰	1.0		
SCDS3D28	3	4.0 ⁺⁰	4.0 ⁺⁰	3 ⁺⁰	4.4	2.8	1.1	
SCDS3D28LD	3	4.0 ⁺⁰	4.0 ⁺⁰	3 ⁺⁰	4.4	2.8	1.1	
SCDS4D18	2	4.7 ± 0.3	4.7 ± 0.3	2.0 ⁺⁰	6.9 ⁺⁰	1.5		
SCDS4D28	2	4.7 ± 0.3	4.7 ± 0.3	3.0 ⁺⁰	6.9 ⁺⁰	1.5		
SCDS5D18	2	5.7 ± 0.3	5.7 ± 0.3	2.0 ⁺⁰	8.2 ⁺⁰	2.0		
SCDS5D28	2	5.7 ± 0.3	5.7 ± 0.3	3.0 ⁺⁰	8.2 ⁺⁰	2.0		
SCDS6D28	2	6.7 ± 0.3	6.7 ± 0.3	3.0 ⁺⁰	9.5 ⁺⁰	2.0		
SCDS6D38	2	7.0 ⁺⁰	7.0 ⁺⁰	4.0 ⁺⁰	9.5 ⁺⁰	2.0		



ELECTRICAL CHARACTERISTICS

STAMP	INDUCTANCE (μH)	DC RESISTANCE (Ω) Max.											
		SCDS 2D09	SCDS 2D11	SCDS 2D14	SCDS 2D18LD	SCDS 2D18H	SCDS 3D16	SCDS 4D18	SCDS 4D28	SCDS 5D18	SCDS 5D28	SCDS 6D28	SCDS 6D38
1R0	1.0							45					
1R2	1.2	97.5							23.6				
1R5	1.5	110	68	63			52						
1R7	1.7					44							
1R8	1.8	131.3		75					27.5				
2R2	2.2	143.8	98	94	41	60	72	75	31.3				
2R5	2.5										18		
2R7	2.7	150		106				105	43.3				
3R0	3.0										24	24	
3R3	3.3	193.8	123	125	54	86	85	110	49.2				20
3R9	3.9	225		138				155	64.8			27	
4R1	4.1									57			
4R2	4.2										31		
4R7	4.7	287.5	170	169	78	140	105	162	72				
5R0	5.0											31	24
5R3	5.3										38		
5R4	5.4									76			
5R6	5.6	325		188				170	100.9				
6R0	6.0											35	
6R2	6.2									96	45		27
6R3	6.3					160							
6R8	6.8	425	260	213	106		170	200	108.9				
7R3	7.3											54	
7R4	7.4												31
8R2	8.2	475		281				245	117.5		53		
8R6	8.6											58	
8R7	8.7												34
8R9	8.9									116			
100	10	537.5	400	294	180	245	210	280	128.3	124	65	65	38
120	12			394				320	131.6	153	76	70	53
150	15				220	345	295	360	149	196	103	84	57
180	18							400	166	210	110	95	92
220	22				320		430	480	235	290	122	128	96
270	27							570	261	330	175	142	109
330	33				460		675	694	331.3	386	189	165	124
390	39							800	383.7	520	212	210	138
470	47				660			950	587	595	250	238	150
560	56							1,080	624.5	665	305	277	202
680	68							1,300	699	840	355	304	234
820	82								914.8	978	463	390	324
101	100								1,020	1,200	520	535	358
121	120								1,270				
151	150								1,350				
181	180								1,540				

Note:

Test Freq.(L): SCDS2D09/2D11/2D14/2D18LP/2D18HP/4D28: 100KHz/1V

SCDS4D18: 1.0 to 8.2 μH (7.96MHz/1V), 10 to 39 μH (100KHz/1V)

SCDS3D16: 100KHz/0.1V; SCDS5D18/5D28/6D28/6D38: 10KHz/1V

Test Instrument: L- HP 4192A LF Impedance analyzer; RDC- CH502BC, Rated Current- HP4284+42841A or CH1061+CH301A

D.C. current when the temperature rising $\Delta T = 40^\circ\text{C}$ lower; whichever is lower:

Tolerance: M = $\pm 20\%$, T = $\pm 30\%$, N = $+40\%$ / -20%

ELECTRICAL CHARACTERISTICS

STAMP	INDUCTANCE (μH)	RATED CURRENT (A)											
		SCDS 2D09	SCDS 2D11	SCDS 2D14	SCDS 2D18LD	SCDS 2D18H	SCDS 3D16	SCDS 4D18	SCDS 4D28	SCDS 5D18	SCDS 5D28	SCDS 6D28	SCDS 6D38
IR0	1.0							1.72					
IR2	1.2	0.80							2.56				
IR5	1.5	0.73	0.90	1.80			1.55						
IR7	1.7					1.85							
IR8	1.8	0.65		1.65					2.20				
2R2	2.2	0.60	0.78	1.50	0.85	1.60	1.20	1.32	2.04				
2R5	2.5										2.60		
2R7	2.7	0.53		1.35				1.28	1.60				
3R0	3.0										2.40	3.00	
3R3	3.3	0.47	0.60	1.20	0.75	1.45	1.10	1.04	1.57				3.50
3R9	3.9	0.45		1.10				0.88	1.44			2.60	
4R1	4.1									1.95			
4R2	4.2										2.20		
4R7	4.7	0.41	0.50	1.00	0.63	1.20	0.90	0.84	1.32				
5R0	5.0											2.40	2.90
5R3	5.3										1.90		
5R4	5.4									1.60			
5R6	5.6	0.37		0.95				0.80	1.17				
6R0	6.0											2.25	
6R2	6.2									1.40	1.80		2.50
6R3	6.3					1.05							
6R8	6.8	0.33	0.44	0.85	0.52		0.73	0.76	1.12				
7R3	7.3											2.10	
7R4	7.4												2.30
8R2	8.2	0.30		0.80				0.68	1.04		1.60		
8R6	8.6											1.85	
8R7	8.7												2.20
8R9	8.9									1.25			
100	10	0.28	0.35	0.70	0.43	0.85	0.55	0.61	1.00	1.20	1.30	1.70	2.00
120	12			0.62				0.56	0.84	1.10	1.20	1.55	1.70



ELECTRICAL CHARACTERISTICS

STAMP	INDUCTANCE (μH)	RATED CURRENT (A)											
		SCDS 2D09	SCDS 2D11	SCDS 2D14	SCDS 2D18LD	SCDS 2D18H	SCDS 3D16	SCDS 4D18	SCDS 4D28	SCDS 5D18	SCDS 5D28	SCDS 6D28	SCDS 6D38
150	15				0.35	0.70	0.45	0.50	0.76	0.97	1.10	1.40	1.60
180	18							0.48	0.72	0.85	1.00	1.32	1.50
220	22				0.30		0.40	0.41	0.70	0.80	0.90	1.20	1.30
270	27							0.35	0.58	0.75	0.85	1.05	1.20
330	33				0.24		0.32	0.32	0.56	0.65	0.75	0.97	1.10
390	39							0.30	0.50	0.57	0.70	0.86	1.00
470	47				0.20			0.28	0.48	0.54	0.62	0.80	0.95
560	56							0.26	0.41	0.50	0.58	0.73	0.85
680	68							0.24	0.35	0.43	0.52	0.65	0.75
820	82								0.32	0.41	0.46	0.60	0.70
101	100								0.29	0.36	0.42	0.54	0.65
121	120								0.27				
151	150								0.24				
181	180								0.22				

Note:

Test Freq.(L): SCDS2D09/2D11/2D14/2D18LP/2D18HP/4D28: 100KHz/1V

SCDS4D18: 1.0 to 8.2 μH (7.96MHz/1V), 10 to 39 μH (100KHz/1V)

SCDS3D16: 100KHz/0.1V; SCDS5D18/5D28/6D28/6D38: 10KHz/1V

Test Instrument: L- HP 4192A LF Impedance analyzer; RDC- CH502BC, Rated Current- HP4284+42841A or CH1061+CH301A

D.C. current when the temperature rising $\Delta T = 40^\circ\text{C}$ lower; whichever is lower:

Tolerance: M = $\pm 20\%$, T = $\pm 30\%$, N = $+40\%$ / -20%

TOLERANCE OF INDUCTORS

SCDS2D09	1.2 to 10 $\mu\text{H} \pm 30\%$	SCDS3D28	3.3 to 47 $\mu\text{H} \pm 30\%$
SCDS2D11	1.5 to 10 $\mu\text{H} \pm 30\%$	SCDS3D28LD	10 to 220 $\mu\text{H} \pm 30\%$
SCDS2D14	1.5 to 12 $\mu\text{H} \pm 30\%$	SCDS4D18	1.0 to 68 $\mu\text{H} \pm 30\%$
SCDS2D18LD	2.2 to 47 $\mu\text{H} \pm 30\%$	SCDS4D28	1.2 to 180 $\mu\text{H} \pm 30\%$
SCDS2D18HP	1.7 to 15 $\mu\text{H} \pm 30\%$	SCDS5D18	4.1 to 100 $\mu\text{H} \pm 30\%$
SCDS3D11	2.7 to 39 $\mu\text{H} \pm 30\%$	SCDS5D28	2.5 to 100 $\mu\text{H} \pm 30\%$
SCDS311HP	0.6 to 22 $\mu\text{H} \pm 30\%$	SCDS6D28	3.0 to 100 $\mu\text{H} \pm 30\%$
SCDS3D16	1.5 to 33 $\mu\text{H} \pm 30\%$	SCDS6D38	3.3 to 100 $\mu\text{H} \pm 30\%$

ELECTRICAL CHARACTERISTICS

STAMP	INDUCTANCE (μ H)	DC RESISTANCE (Ω) Max.				RATED CURRENT (A)				I _{rms} (A) Typ.			
		SCDS 3D11	SCDS 3D11HP	SCDS 3D28	SCDS 3D28LD	SCDS 3D11	SCDS 3D11HP	SCDS 3D28	SCDS 3D28LD	SCDS 3D11	SCDS 3D11HP	SCDS 3D28	SCDS 3D28LD
R60	0.6		0.059				2.90				1.80		
1R2	1.2		0.082				2.00				1.70		
1R5	1.5		0.104				1.85				1.45		
2R2	2.2		0.143				1.60				1.15		
2R7	2.7	0.078				0.53				1.82			
3R3	3.3		0.182	0.0721			1.25	2.00			0.95	1.85	
4R7	4.7	0.123	0.234	0.0883		0.40	1.00	1.65		1.38	0.90	1.62	
6R8	6.8	0.180	0.377	0.1190		0.34	0.85	1.24		1.05	0.70	1.32	
8R2	8.2	0.204				0.32				0.93			
100	10	0.240	0.413	0.1450	0.095	0.28	0.80	1.05	0.50	0.90	0.60	1.18	1.52
120	12	0.276	0.585		0.100	0.25	0.64		0.45	0.81	0.48		1.48
150	15	0.372	0.653	0.2130	0.115	0.23	0.58	0.90	0.40	0.68	0.45	1.02	1.44
180	18	0.468	0.888		0.125	0.21	0.52		0.35	0.58	0.40		1.37
220	22	0.540	1.010	0.3350	0.145	0.19	0.45	0.76	0.33	0.53	0.33	0.74	1.28
270	27	0.726			0.175	0.17			0.29	0.48			1.18
330	33	0.822		0.4810	0.215	0.15		0.58	0.28	0.41		0.63	1.15
390	39	0.942			0.225	0.14			0.25	0.40			1.00
470	47			0.5990	0.305			0.48	0.23			0.56	0.81
560	56				0.325				0.20				0.76
680	68				0.470				0.19				0.60
820	82				0.540				0.17				0.58
101	100				0.610				0.16				0.52
121	120				0.755				0.14				0.50
151	150				0.880				0.12				0.48
181	180				1.130				0.12				0.42
221	220				1.270				0.12				0.36

Note:

Test Freq.(L): 100KHz/1V

Test Instrument: L- HP4284A, RDC- CH502BC, Rated Current- HP4284+42841A or CH1061+CH301A

Rated current: The rated current indicates the current when the inductance decreases to 65%

I_{rms}: D.C. current when the temperature rising $\Delta T = 40^\circ\text{C}$

Tolerance: T = $\pm 30\%$



TAPE DIMENSIONS

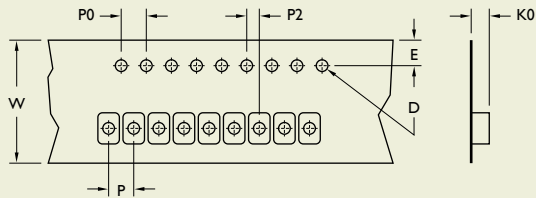

TAPE MATERIAL

Carrier Tape: Polystyrene

Cover Tape: Polyethylene

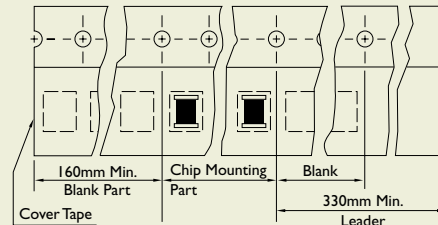

REEL DIMENSIONS

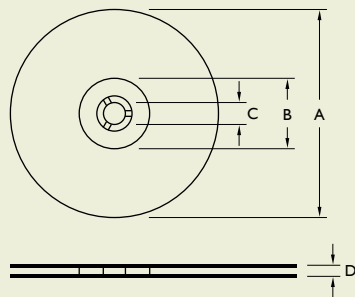

RECOMMENDED PATTERN

Figure 1

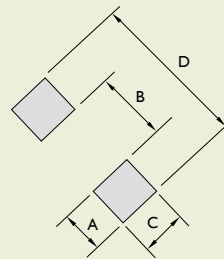
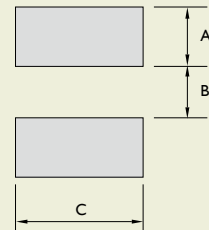

Figure 2



Dimensions: mm

TYPE	TAPE DIMENSIONS							RECOMMENDED PATTERN				REEL DIMENSIONS				QUANTITY/ REEL	
	K0	D	E	W	P	P0	P2	FIGURE	A	B	C	D	A	B	C		D
SCDS2D09	1.40	1.55	1.75	12	8	4	2	1	1.3	1.7	1.3	4.3	178	60	13	13.2	1,000
SCDS2D11	1.40	1.55	1.75	12	8	4	2	1	1.3	1.7	1.3	4.3	178	60	13	13.2	1,000
SCDS2D14	1.70	1.55	1.75	12	8	4	2	1	1.3	1.7	1.3	4.3	178	60	13	13.2	1,000
SCDS2D18LD	2.10	1.55	1.75	12	8	4	2	1	1.3	1.7	1.3	4.3	178	60	13	13.2	1,000
SCDS2D18HP	2.10	1.55	1.75	12	8	4	2	1	1.3	1.7	1.3	4.3	178	60	13	13.2	1,000
SCDS3D11	1.50	1.55	1.75	12	8	4	2	1	1.4	2.4	1.5	5.2	178	60	13	13.2	1,000
SCDS3D11HP	1.50	1.55	1.75	12	8	4	2	1	1.4	2.4	1.5	5.2	178	60	13	13.2	1,000
SCDS3D16	2.00	1.50	1.75	12	8	4	2	2	1.6	1.4	4.6	-	178	60	13	13.2	1,000
SCDS3D28	3.20	1.55	1.75	12	8	4	2	1	1.4	2.4	1.5	5.2	178	60	13	13.2	500
SCDS3D28LD	3.20	1.55	1.75	12	8	4	2	1	1.4	2.4	1.5	5.2	178	60	13	13.2	500
SCDS4D18	2.40	1.50	1.75	12	8	4	2	2	1.9	1.5	5.3	-	330	100	13	13.4	2,000
SCDS4D28	3.40	1.50	1.75	12	8	4	2	2	1.9	1.5	5.3	-	330	100	13	13.4	2,000
SCDS5D18	2.20	1.50	1.75	12	8	4	2	2	2.15	2.0	6.3	-	330	100	13	13.4	2,000
SCDS5D28	3.20	1.50	1.75	12	8	4	2	2	2.15	2.0	6.3	-	330	100	13	13.4	2,000
SCDS6D28	3.20	1.50	1.75	16	12	4	2	2	2.65	2.0	7.3	-	330	100	13	17.4	1,500
SCDS6D38	4.10	1.50	1.75	16	12	4	2	2	2.65	2.0	7.3	-	330	100	13	17.4	1,000